

**FAG**



# Lubrication System FAG CONCEPT8

User manual

**SCHAEFFLER**



# Contents

	Page
<b>About the user manual</b>	
Symbols .....	3
Availability .....	3
Legal guidelines .....	3
Original user manual .....	3
<b>General safety guidelines</b>	
Principles .....	4
Usage for the intended purpose .....	5
Usage not for the intended purpose .....	5
Warranty.....	5
Selection and qualification of personnel .....	6
Warning notice .....	7
Safety specifications .....	8
<b>Scope of delivery</b> .....	10
<b>Description</b>	
Design.....	12
Communication interface and connection to FAG CONCEPT8.....	16
Basic operation .....	17
Function .....	18
<b>Transport and storage</b> .....	18
<b>Mounting</b>	
Mechanical mounting .....	19
<b>Commissioning</b>	
Carrying out commissioning.....	20
Inserting the lubricant cartridge .....	20
Connecting the lubrication system to the lubrication point .....	22
Connecting the operating voltage.....	24
Bleeding the lubrication system .....	25

# Contents

	Page
<b>Operation</b>	
Operating modes .....	27
Time control.....	30
Pulse control.....	44
Output signals at PIN 4.....	58
Master PIN .....	60
<b>Troubleshooting and rectification</b>	60
E1 – Empty level display.....	61
E2 – Original cartridge missing.....	61
E3 – Pump body motor too slow .....	62
E4 – Internal electrical defect .....	63
E5.....	63
E6.....	63
E7 – Back pressure too high .....	64
E8.....	64
<b>Maintenance</b>	
Device memory readout.....	65
Replacing the cartridge .....	67
Service .....	69
<b>Decommissioning</b>	69
<b>Disposal</b> .....	69
<b>Technical data and accessories</b>	
Technical data .....	70
Accessories .....	73

# Lubrication system FAG CONCEPT8

- About the user manual** The purpose of this user manual is to assist the user become acquainted with the lubrication system FAG CONCEPT8 and use it for the intended purpose.  
This user manual describes the installation and use of the lubrication system FAG CONCEPT8 and is intended to help in:
- avoiding hazards
  - increasing the reliability and service life of the device.
- This user manual is part of the device and contains important information. It is applicable only to the lubrication systems FAG CONCEPT8, FAG CONCEPT8-CC and FAG CONCEPT8-LIN.
- Symbols** The warning and hazard symbols are defined along the lines of ANSI Z535.6–2006.
- NOTICE** In case of non-compliance, damage or malfunctions in the product or the adjacent construction will occur. ◀
- Note** There follows additional or more detailed information that must be observed.
- Availability** This user manual is supplied with each device and can also be ordered retrospectively.
- Note** If the user manual is absent, incomplete or illegible, the user may lack important information relating to safe use of the device and this may lead to incorrect usage. It must be ensured that this user manual is always complete and legible and that any persons using the device have the user manual available.
- Legal guidelines** The information in this manual corresponded to the most recent status at the close of editing. The illustrations and descriptions cannot be used as grounds for any claims relating to devices that have already been delivered. Schaeffler Technologies AG & Co. KG accepts no liability for any damage or malfunctions if the device or accessories have been modified or used in an inappropriate manner.
- Original user manual** This user manual is the original user manual.

# Lubrication system FAG CONCEPT8

**General safety guidelines** This chapter brings together all the important safety regulations. Any person charged with working on the lubrication system must read this chapter and observe the guidelines.

**Principles** The lubrication system FAG CONCEPT8 corresponds to the current level of technology and the recognised rules of safety practice. If the safety guidelines are not observed, risks to life and limb for the user or third parties and extensive damage to other material assets may nevertheless arise during use.

Non-compliance with the safety guidelines may have the following consequences:

- failure of important functions of the equipment
- failure of specified methods for maintenance and overhaul
- endangerment of persons through electrical, mechanical and chemical action
- endangerment of the environment through leakage of hazardous substances.

**Marking** Each lubrication system FAG CONCEPT8 is marked by means of a serial number and nameplate. The nameplate contains information on the manufacturer and the CE symbol, *Figure 1*.

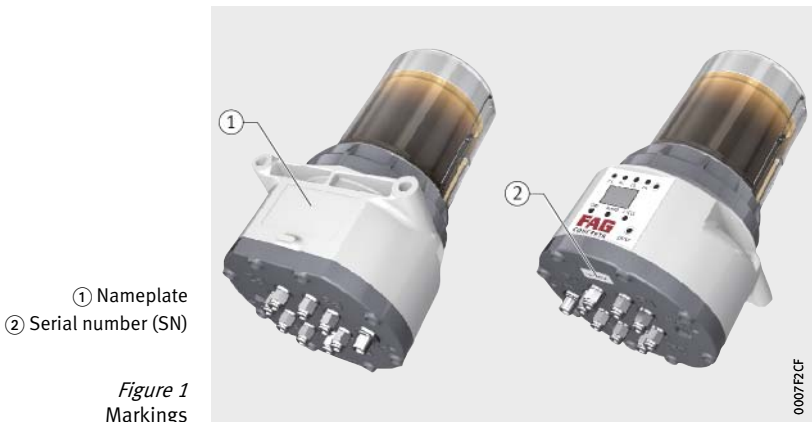

**Usage for the intended purpose**

The lubrication system FAG CONCEPT8 is authorised for use only in a normal industrial environment or outdoors. The lubrication system FAG CONCEPT8 may only be used in accordance with the technical data, see page 70.

Only original cartridges and original replacement parts may be used, in order to prevent malfunctions or failure of the pumps.

Unauthorised modifications to the structure of the lubrication system FAG CONCEPT8 are not permissible. We assume no liability for any damage to machinery or injury to persons arising from such actions.

Usage for the intended purpose also includes:

- compliance with all guidelines in the user manual
- implementation of all maintenance work
- compliance with all relevant specifications on occupational safety and accident prevention during all life cycles of the lubrication system FAG CONCEPT8
- the necessary specialist training and authorisation of your company for carrying out the necessary work on the lubrication system FAG CONCEPT8.

**Usage not for the intended purpose**

The lubrication system FAG CONCEPT8 may not be used in or on vehicles.

The lubrication system may not be used in environments with an explosion risk.

**Warranty**

The manufacturer shall assume liability for warranties in relation to operational security, reliability and performance only under the following conditions:

- Mounting, connection, maintenance and repairs must be carried out by authorised and skilled personnel.
- If hot or cold machine parts constitute a hazard, measures must be taken locally to prevent contact with these parts.
- The lubrication system FAG CONCEPT8 must be used in accordance with the information in the technical data sheets.
- The limit values indicated in the technical data may not be exceeded under any circumstances.
- Conversion and repair work on lubrication systems FAG CONCEPT8 may only be carried out by the manufacturer.

# Lubrication system FAG CONCEPT8

## Selection and qualification of personnel

The lubrication system FAG CONCEPT8 may only be mounted, commissioned, operated and maintained by qualified personnel. The scope of competence, area of responsibility and monitoring of personnel must be precisely regulated by the site operator.

A person defined as qualified personnel:

- is authorised to carry out mounting of the lubrication system FAG CONCEPT8
- has all the necessary knowledge
- is familiar with the safety guidelines
- has read and understood this manual.

If personnel do not possess the necessary knowledge, they must be given the necessary training and instruction.

Upon request, Schaeffler can offer appropriate training courses.

## Work on electrical devices

Work on electrical devices may only be carried out by a trained electrician.

A trained electrician is in a position, on the basis of his technical training, knowledge and experience as well as his knowledge of the appropriate regulations, to assess the work assigned to him and recognise possible hazards.



**Warning notice** Read this document before commissioning the device. Make sure you are certain that the product is suitable without restrictions for the relevant applications.

The lubrication system FAG CONCEPT8 is not classified as a safety component in accordance with the Machinery Directive 2006/42/EC. The device may only be installed by a trained electrician.

Carry out the installation in accordance with the national and international regulations covering the installation of electro-technical equipment.

Before mounting the device, check for any external damage. If damage or some other defect is found, the device must not be commissioned.

Any interference in or modifications to the device, or the addition or removal of inappropriate components is impermissible, can endanger occupational safety and may render null and void any warranty claim.

Any work on wiring, opening or closing of electrical connections may only be performed while disconnected from the power supply and in a voltage-free state.

The use of the lubrication system FAG CONCEPT8 is only permissible within the boundaries of the conditions stated and illustrated in the user manual.

The lubrication system FAG CONCEPT8 may only be operated within the limits described in the data sheet. If the lubrication system FAG CONCEPT8 is operated outside these limits, the device may be damaged or destroyed.

If a lubrication system FAG CONCEPT8 is damaged, do not attempt any repairs. Any repairs necessary must be carried out by Schaeffler Technologies AG & Co. KG.

Any unused outlets on the lubricator FAG CONCEPT8 must **not be closed off**. If both outlets for one pump are to be joined for one lubrication point, for example if there is an uneven number of lubrication points, a Y type connector must be used to join the two pump outlets, see page 73.

The closing plugs installed on the lubrication system FAG CONCEPT8 may not be removed or replaced.

Do not dismount the lubrication system FAG CONCEPT8 unless it is in a voltage-free state.

# Lubrication system FAG CONCEPT8

**Safety specifications** All important safety specifications are described in the following sections.

**Guidelines for the site operator** If movable, rotating, hot or cold machine parts constitute a hazard, measures must be taken locally to prevent contact with these parts. The protection against contact must not be removed in the case of movable or rotating parts.

Leakages of hazardous substances must be directed away such that hazards to persons and the environment do not occur.

Legal requirements must be observed.

Hazards resulting from electrical energy must be eliminated.

**Transport and storage** Use suitable lifting gear for transport.

In transport, the relevant safety and accident prevention guidelines must be observed. Where necessary, suitable protective equipment must be worn.

The lubrication system FAG CONCEPT8 must not be thrown or subjected to strong impacts.

The lubrication system FAG CONCEPT8 must be stored under cool, dry conditions, in order to avoid promoting corrosion of individual parts of the device.

**Mounting** The housing of the lubrication system FAG CONCEPT8 must not be subjected to direct sunlight or direct radiated heat. Risk of condensation.

Mounting and connection of the lubrication system FAG CONCEPT8 may only be carried out by qualified personnel and in compliance with accident prevention regulations.

**Work on electrical devices** When making connections to an electrical device, the following must be observed:

- connection to the voltage supply only by trained electricians
- correct wiring of the electrical components of the device
- comparison of the voltage data with the available mains voltage.

**Maintenance and repair work** Maintenance and repair work may only be carried out by qualified professionals and in compliance with accident prevention regulations. Personal protective equipment must be used for all work.

The lubrication system FAG CONCEPT8 must be placed in a voltage-free state before starting maintenance and repair work.

All maintenance and repair work must be carried out when the device is completely shut down.

During maintenance and repair work, the device must be secured against intentional or unintentional recommissioning.

If any safety devices must be removed during maintenance or repair, these must be refitted once the work is complete and their function must be checked.

When carrying out maintenance and repair work, only suitable tools may be used and these must be used correctly.

Any indirect process materials must be disposed of in accordance with the appropriate safety datasheets from the lubricant manufacturer.

**Troubleshooting and rectification** Troubleshooting and rectification may only be carried out by qualified professionals and in compliance with accident prevention regulations. Personal protective equipment must be used for all work.

**Disposal** Any used lubrication systems FAG CONCEPT8 and grease-soaked materials must be disposed of by environmentally acceptable methods.

Electronic devices must be disposed of in accordance with the relevant regulations.

**Constructional modifications (conversion)** For safety reasons, autonomous modifications of the lubrication system FAG CONCEPT8 are not permitted.

Modification and changes to the device are only permissible in agreement with the manufacturer. Only original replacement parts and accessories authorised by the manufacturer may be used.

If other parts are used, this may invalidate liability for any consequences. The manufacturer will accept neither warranty claims nor claims for damages for components retrofitted by the site operator.

In order to comply with directives on electromagnetic compatibility (EMC), no modifications may be made to the electrical installation (cables, shielding).

# Lubrication system FAG CONCEPT8

**Scope of delivery** The lubrication system FAG CONCEPT8 is available in various designs.

CONCEPT8 (Standard) The scope of delivery comprises:

- lubrication system FAG CONCEPT8 with one, two, three or four pump elements
- hose connectors mounted on the outlets for medium pressure polyamide hose 8×5 (outside diameter 8 mm and inside diameter 5 mm)
- user manual.

CONCEPT8-LIN (Linear) The scope of delivery comprises:

- lubrication system FAG CONCEPT8 with one, two, three or four pump elements
- hose connectors mounted on the outlets for medium pressure polyamide hose 6×4 (outside diameter 6 mm and inside diameter 4 mm)
- user manual.

CONCEPT8-CC (Cold Climate) The scope of delivery comprises:

- lubrication system FAG CONCEPT8 with one, two, three or four pump elements
- hose connector for medium pressure polyamide hose 8×5 (outside diameter 8 mm and inside diameter 5 mm)
- integrated heating system
- user manual.

Required accessories In order to obtain a complete system ready for operation, the following accessories must also be ordered, *Figure 2*:

- grease cartridge LC800
- hose connectors for lubrication point
- hoses
- connection cable or mains power pack including connection cable.

The available accessories can be found on page 70.



# Lubrication system FAG CONCEPT8

## Description

### Design

The lubrication system FAG CONCEPT8 is a highly compact lubricant pump for minimal quantity lubrication, *Figure 3*. It includes up to four pump bodies (P1, P2, P3, P4), each with two outlets. A pump body is a piston pump with two outlets that are operated alternately and dispense identical quantities.

Minimum quantity lubrication ensures the controlled and efficient supply of a lubrication point with selected, very high quality lubricants.

The lubrication system FAG CONCEPT8 can be operated by means of an external controller or by the integral time control system.

The voltage supply required is DC 24 V. The greases are held in a cartridge with a lubricant volume of 800 cm<sup>3</sup>. The delivery pressure is a maximum of 70 bar.

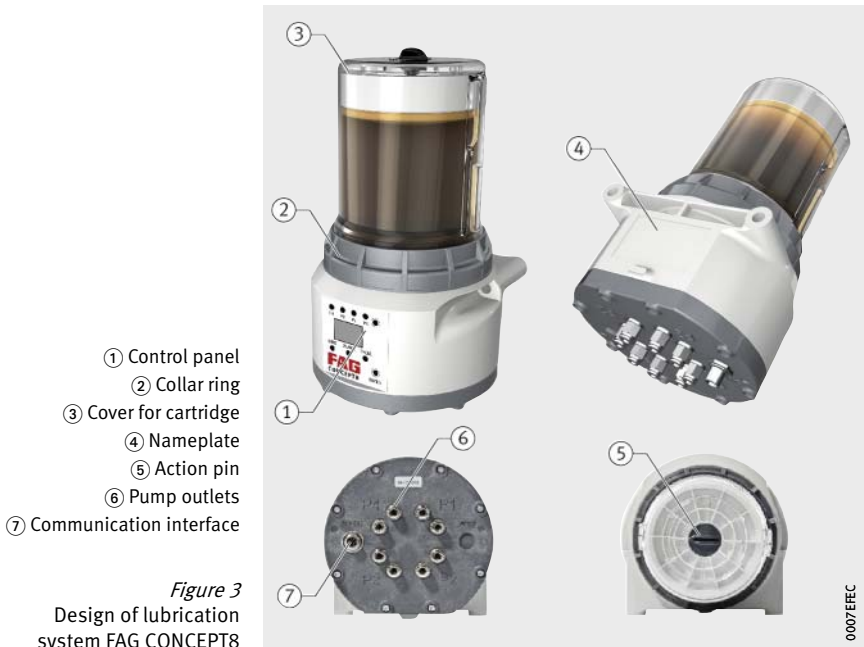

## Definitions of terms

Function	Description
run	<p>Back pressure checking by special dispensing:</p> <ul style="list-style-type: none"> <li>For test and trial purposes, the lubricant pump fitted can be used for the delivery of small quantities of lubricant by means of a simple input/action. In this case, the pressure between the lubrication point and the lubrication pump is estimated, taking account of numerous factors. The displayed value gives an initial guide to the pressure range in bar.</li> </ul>
Pro	Programming mode (other functions), PIN protected
ESC	Exit the menu level
On	Operating mode: time control
Pu0	
PAU	Operating mode: pulse control
Pu1	
TIME	Time between lubrication operations in h
CYCLE	Number of delivery strokes per interval
CLr	Delete critical error messages and terminate fill cycles (FIL) prematurely
FIL	Control function for commissioning
F1	Feedback function
F0	<p>Feedback = motor run control:</p> <ul style="list-style-type: none"> <li>After activation of the outlets, the output signal at PIN 4 for the time of the actual motor run (max. 20 s per outlet) is switched from HIGH to LOW (0 V). The number of confirmed motor runs can be used to estimate depletion. If the feedback function is switched off (F0), the output signal at PIN 4 is permanently HIGH if the pump is operating correctly.</li> </ul>

# Lubrication system FAG CONCEPT8

**Pump** The lubrication system FAG CONCEPT8 has a minimum of one pump body and a maximum of four pump bodies (P1, P2, P3, P4) each with two outlets, *Figure 4*. A pump body comprises a piston pump with two outlets that are operated alternately and dispense identical quantities.



*Figure 4*  
Lubrication system  
FAG CONCEPT8

0007EE8

**Pump bodies and outlets** Each active pump body P1, P2, P3, P4 is displayed on the control panel by a green LED, *Figure 5*. Each active outlet is shown during a function by a number (1 or 2) on the display.

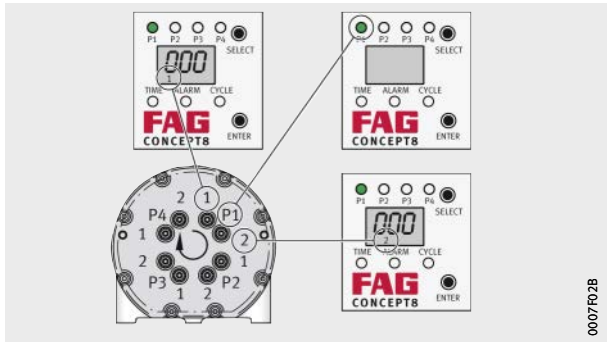
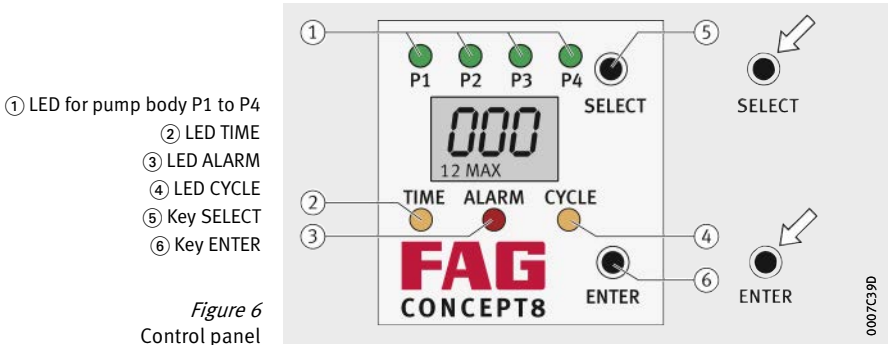

*Figure 5*  
Overview of  
pump bodies and outlets

0007FO2B



**Control panel** The control panel comprises a display, two input elements and several LEDs, *Figure 6*. The control panel is used for the input of parameters as well as the output of status messages, see *table*.

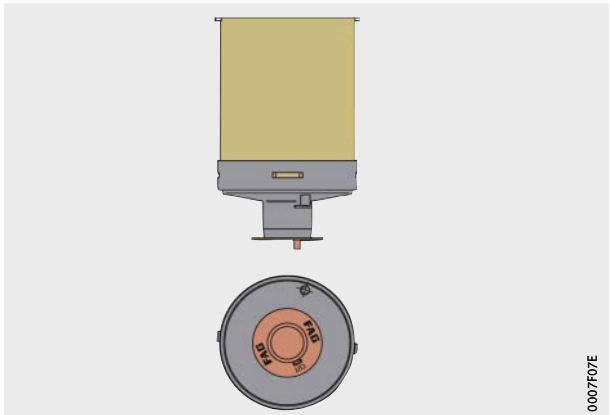

*Figure 6*  
Control panel

**Control elements and displays**

Description	Display
Pump body P1, P2, P3, P4	Green LED
Pause times (TIME)	Orange LED
Messages (ALARM)	Red LED
Lubrication quantity (CYCLE)	Orange LED

**Cartridge** The cartridge contains the lubricant and has a volume of 800 cm<sup>3</sup>, *Figure 7*.

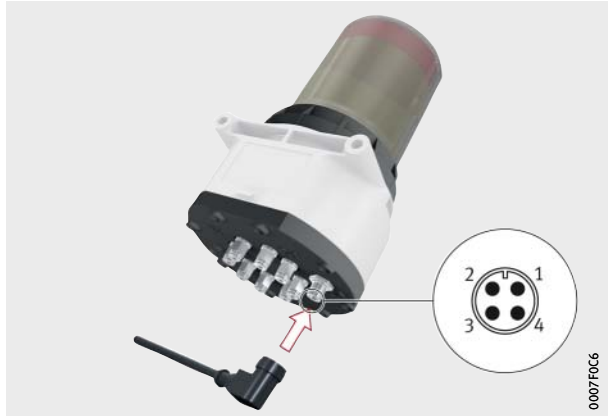

*Figure 7*  
Cartridge

# Lubrication system FAG CONCEPT8

## Communication interface and connection to FAG CONCEPT8

Electrical connection of the lubrication system FAG CONCEPT8 is carried out via the communication interface. On the underside of the lubrication system is a 4 pin connector with an external thread to which the connection cable or mains power pack is connected, *Figure 8*.



*Figure 8*  
Connection of  
FAG CONCEPT8

### Connector assignment of connector M12×1

PIN	Assignment	Colour
PIN 1	Input voltage DC 24 V (–5% to +10%), operating voltage stabilised at DC 24 V	Brown
PIN 2	Pulses for activation of individual pump outlets (only when using pulse control)	White
PIN 3	Output, ground (GND)	Blue
PIN 4	Output signal	Black

The data relate to a voltage supply of DC 24 V, see *table*.

### Voltage supply

Designation	Value
Peak current $I_{\max}$ during pump operation	350 mA
typical	< 200 mA
Idle current ready	< 50 mA
typical	20 mA
Maximum output current (at PIN 4), no inductive loads	100 mA

The peak current is increased by the output current drawn, for example 350 mA + 100 mA = 450 mA.



Observe polarity, since the electrical system is not short-circuit proof. Recommendation: Protection by 1 A delayed-action fuse.

**Basic operation** All changes to settings are made using the action pin in the upper housing part. The action pin is the bleed screw in the upper housing part. The action pin is a magnetic switch by means of which the action fields SELECT and ENTER can be activated.



For reasons of functional safety, no inputs can be made using the action pin while the pump motors are running. Even if external control by means of a PLC is used, no inputs will be recognised during this time.

**Removing the action pin** The action pin is removed as follows, *Figure 9*:

- ▶ Loosen the action pin by rotating it from CLOSE to OPEN.
- ▶ Remove the action pin from the upper housing part.



*Figure 9*

Removing the action pin

**Securing the action pin** The action pin is secured as follows:

- ▶ Insert the action pin in the upper housing part.
- ▶ Secure the action pin by rotating it from OPEN to CLOSE.

0008965A

# Lubrication system FAG CONCEPT8

**Function** Once the lubrication system FAG CONCEPT8 has been successfully mounted and commissioned, it is ready for operation after applying the supply voltage. The integrated pumps deliver the lubricant to the outlets, the internal controller monitoring not only the lubricant quantity set, but also the time intervals between the lubrication operations.

For connection to an existing machine or equipment controller, for example an external controller (PLC), each lubrication system has a four-pin connector for connection of a M12×1 jack. This connection is used for communication with an external controller as well as voltage supply.

The voltage for operation and for switching the lubrication system CONCEPT8 on and off is DC 24 V (–5% to +10%).

When voltage is applied, the lubricant pump is in operation.

If no malfunctions are present, which means that the lubrication system is OK, the supply voltage is applied to the output PIN 4.

A continuous LOW signal indicates an error. If the voltage is switched off, the lubrication system stops and saves the current mode.

At restart, for example due to power up, the saved mode is resumed. The operating mode is outputted via PIN 4.

**Transport and storage** Use suitable lifting gear for transport.

Do not throw the lubrication system FAG CONCEPT8 or subject it to strong impacts.

For transport, observe the relevant safety and accident prevention guidelines. Where necessary, wear suitable protective equipment.

For storage of the lubrication system FAG CONCEPT8, the storage location must be kept cool and dry, in order to avoid promoting corrosion of individual parts of the device.

## Mounting

### Mechanical mounting

For mounting of the lubrication system, two hexagonal socket head screws M8×80 or longer in accordance with DIN 912 are required, which are not included in the scope of delivery, *Figure 10*.

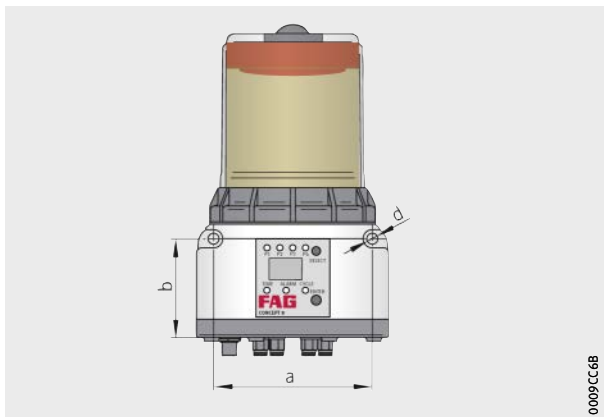

*Figure 10*  
Mounting dimensions of  
FAG CONCEPT8

### Dimensions

Dimension		Value	Unit
Distance between holes	a	130 ± 0,3	mm
Distance between hole centre and lower edge of lubrication system	b	81,2 ± 0,3	mm
Hole diameter	d	9	mm

### Locating the lubrication system

The lubrication system is located as follows:

- ▶ Screw mount the lubrication system FAG CONCEPT8 on the intended mounting area. Ensure a free space of at least 200 mm above the upper edge of the lubrication system, so that the cartridge cover can be removed.
- ▶ Place the lubrication system directly on the wall and locate it by means of two hexagonal socket head screws M8×80 in accordance with DIN 912.
- ▶ Secure the screws against loosening by means of a medium strength screw retaining fluid.
- ▷ The lubrication system is now fixed to the wall.

# Lubrication system FAG CONCEPT8

## Commissioning

### Carrying out commissioning

Commissioning of the lubrication system comprises the following steps:

- insertion of the lubricant cartridge
- preparation of the lubrication points and lubricant pipes
- filling of the lubricant pipes and hose connectors
- connection of the lubrication system to the voltage supply or external controller
- bleeding of the lubrication system
- connection of the lubricant pipes.

### Inserting the lubricant cartridge

The lubricant cartridge is inserted as follows, *Figure 11*:

#### **NOTICE**

The upper housing part is preloaded. Risk of injury due to parts springing off when opening the upper housing part. Carefully loosen the collar ring and upper housing part. ◀

- ▶ Rotate the collar ring on the upper housing part anticlockwise.
- ▶ Carefully remove the upper housing part.
- ▶ Remove the retaining cover of the grease cartridge.
- ▶ Insert the cartridge by rotating it clockwise. Ensure that the stud engages in the slot in the lower part.
- ▶ Position the upper housing part under light pressure and tighten the collar ring finger tight until it stops.
- ▷ The grease cartridge is now inserted.

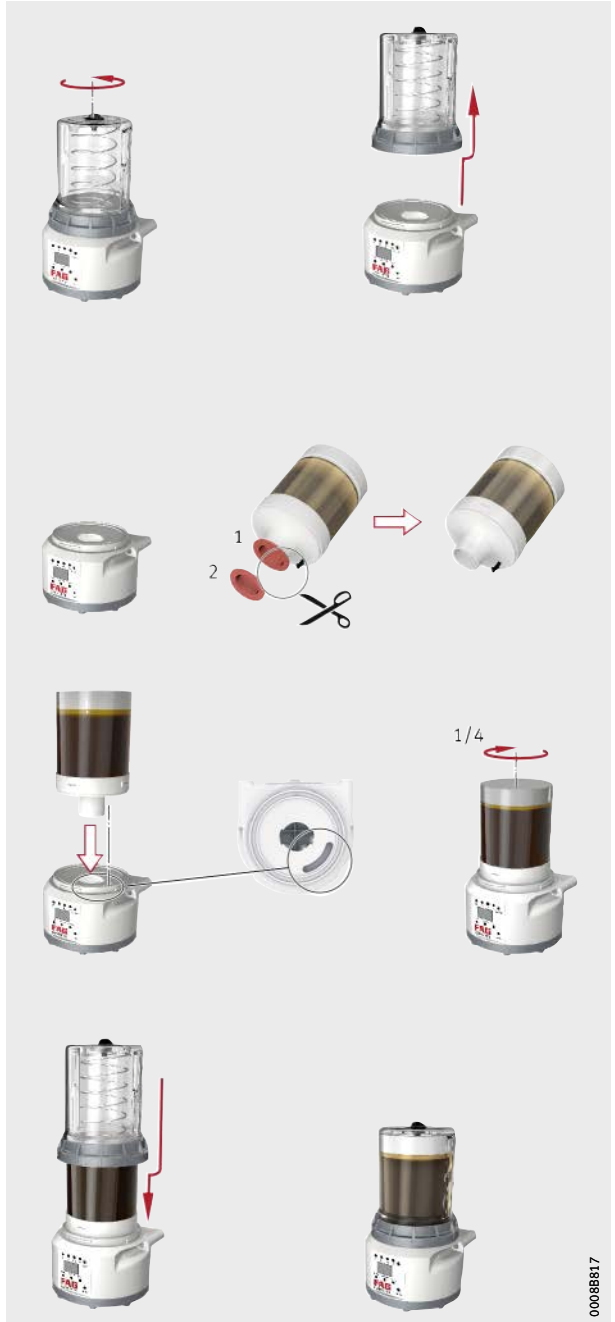

Figure 11  
Inserting the lubricant cartridge

00088817

# Lubrication system FAG CONCEPT8

## Connecting the lubrication system to the lubrication point

Before connecting the lubrication system to the lubrication points, observe the following:

- Where possible, mixing of different greases should be avoided.
- If the grease to be used is different from the grease present at the lubrication point, the old grease must be completely removed from the lubrication point and the lubrication point should be prefilled with the new grease. If this is not feasible for design reasons, as much of the old grease as possible must be removed and the lubrication point must be prefilled as necessary with the new grease.
- It must always be ensured that the lubrication points are appropriately prefilled.

Always ensure that all the hoses are completely inserted in all the hose connectors and Y connectors used, in order to ensure the sealing integrity of the system, *Figure 12*.

Hose connectors for hose 8×5 mm:  
insertion depth  $S = 18$  mm

Hose connectors for hose 6×4 mm:  
insertion depth  $S = 16$  mm

Y type connectors for hose 8×5 mm und 6×4 mm:  
insertion depth  $S = 16$  mm

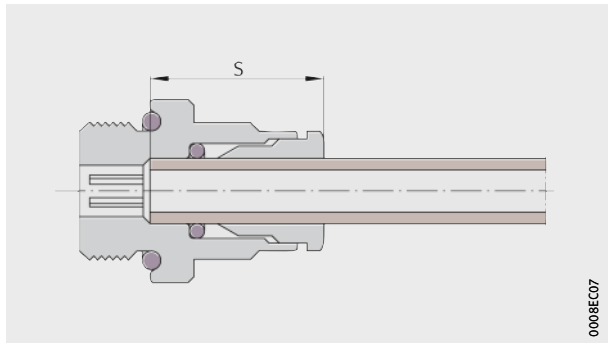

*Figure 12*  
Insertion depth



Pull gently on the inserted hose in order to check the secure seating of the hose in the hose connection.



### Connecting the lubrication system

- ▶ Screw the hose connector into the lubrication point. Observe the thread size.
- ▶ Insert one hose end into the hose connector of the lubrication point.
- ▶ Lay the hose from this point to the selected connector in the lubrication system FAG CONCEPT8. Lay hoses as straight as possible and with large bending radii.
- ▶ Observe the maximum hose length.
- ▶ Cut the hose off at its final length. Ensure that the hose end is cut straight.
- ▶ Remove the hose end again from the lubrication point.

#### **NOTICE**

Damage due to high pressure. Damage to the hoses due to excessive pressure in filling using a hand-lever press. When filling the hoses using a hand-lever press, the pressure must not exceed 70 bar. ◀

- ▶ Fill the hose using a hand-lever press until grease emerges from the hose end. Use the same grease as in the CONCEPT8 cartridge.
- ▶ Insert the hose end into the hose connector of the lubrication point until it stops.
- ▶ Make two more slow strokes with the hand-lever press in order to fill the hose connectors. Do not exceed the maximum pressure of 70 bar.
- ▶ Remove the hand-lever press from the hose.

## Lubrication system FAG CONCEPT8

- ▶ Carry out the steps for hose mounting, cutting to length and prefilling for all lubrication points as described.
- ▶ Bleed the lubrication system before mounting the hose, see page 25.
- ▶ After bleeding, insert the prefilled hose or hoses into the hose connectors of the lubrication system until they stop.



If both outlets for one pump are to be joined for one lubrication point, for example if there is an uneven number of lubrication points, a Y type connector must be used to join the two pump outlets, see page 73. If Y type connectors are used, both the Y type connectors and the associated hose sections must be prefilled.

- ▶ Open the grease outlet holes at the lubrication point so that the grease can exit the housing via the grease outlet holes. This will prevent the back pressure increasing and possibly pressing the seals out of their seat during operation.
- ▷ The lubrication system is now connected to the lubrication points and can be put into operation.

The accessories available for filling can be found on page 75.

### Connecting the operating voltage

The operating voltage can be connected as follows:

- ▶ Connect the 4 pin connector to the lubrication system.
- ▷ The lubrication system is now switched on and is running the operating mode of time control, *Figure 13*.
- ▷ The lubrication system is now ready for operation.

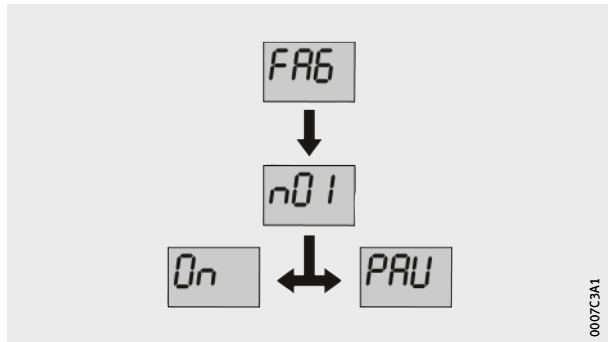

*Figure 13*  
Starting the lubrication system

## **Bleeding the lubrication system**

The lubrication system is bled as follows, once the operating voltage has been connected, *Figure 14*, page 26:

- ▶ Call up the menu item Pro.
- ▶ Press the SELECT key twice in order to call up the menu item Pro.
- ▷ The display will show Pro.
- ▶ Press the ENTER key.
- ▷ The menu item PIN Input is selected.
- ▶ Press the SELECT key in order to input the first value.
- ▶ Press the ENTER key to confirm.
- ▶ Press the SELECT key in order to input the second value.
- ▶ Press the ENTER key to confirm.
- ▶ Press the SELECT key in order to input the third value.
- ▶ Press the ENTER key to confirm.
- ▷ The PIN is inputted. Further menu items can now be called up or changed.
- ▶ Within the Pro menu, go to the menu item FIL.
- ▶ Press the SELECT key as often as necessary until the display shows FIL.
- ▶ Press the ENTER key.
- ▷ The function FIL is selected.
- ▷ The LED for pump 1 will light. The display shows FIL.
- ▶ Press the ENTER key.
- ▷ The pump will be bled.
- ▷ The selected pump body is active 15 times per outlet and delivers lubricant. The total duration for carrying out the function FIL once is approx. 9 minutes per pump body.

## Lubrication system FAG CONCEPT8

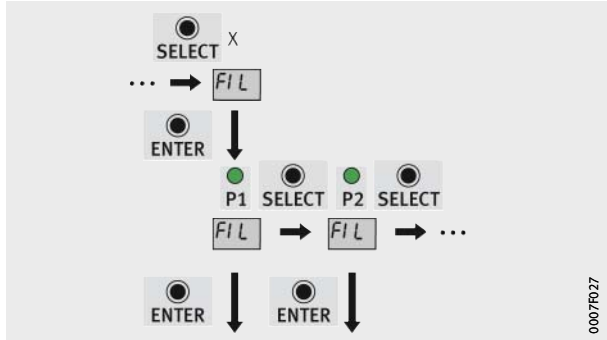

Figure 14  
Bleeding the pump

- Carry out the function FIL for as long as necessary until grease emerges from the outlets. It may be necessary to carry out the function FIL several times until lubricant emerges.

This bleed operation must be carried out individually on all pump bodies and outlets.

The function FIL can be terminated between delivery strokes using CLr.

## Operation

### Operating modes

The lubrication system FAG CONCEPT8 can run in two different operating modes, *Figure 15*:

- time control (time mode) by means of the integrated microcontroller (default setting), *Figure 16*
- pulse control by means of connection to an external controller, *Figure 17*, page 28.

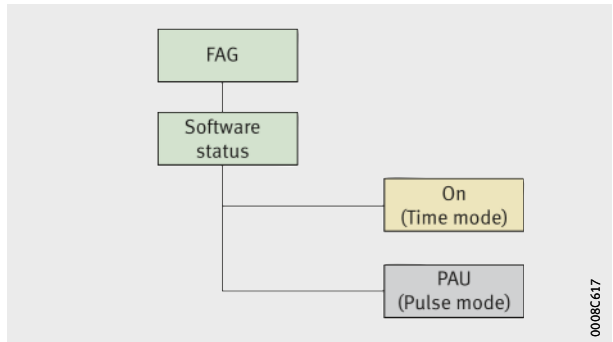

*Figure 15*  
Operating modes of lubrication system FAG CONCEPT8

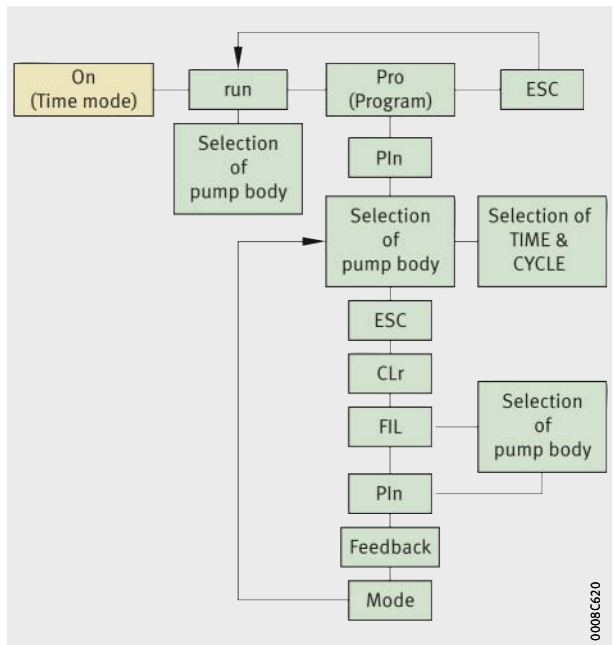

*Figure 16*  
Time control

# Lubrication system FAG CONCEPT8

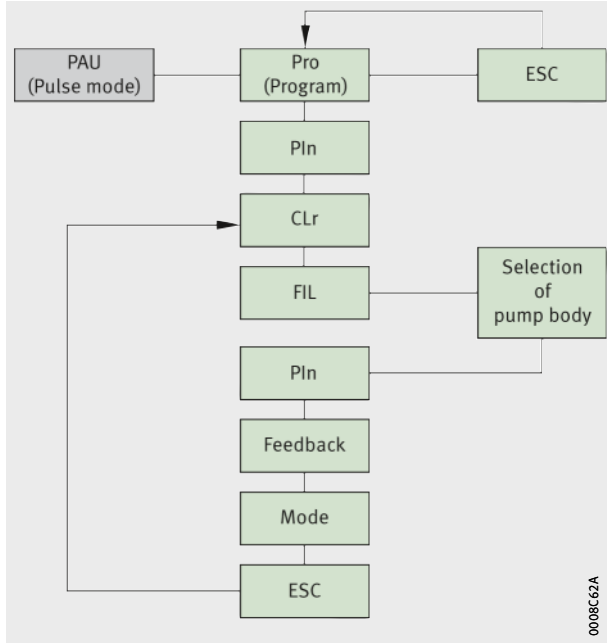

Figure 17  
Pulse control

If the lubrication system FAG CONCEPT8 is to be operated with an external controller, the operating mode must be reset to pulse control.

### Selecting the operating mode

The operating mode is selected as follows:

- ▶ Press the SELECT key twice in order to call up the menu item Pro.
- ▷ The display will show Pro.
- ▶ Press the ENTER key.
- ▷ The menu item PIN Input is selected.
- ▶ Press the SELECT key in order to input the first value.
- ▶ Press the ENTER key to confirm.
- ▶ Press the SELECT key in order to input the second value.
- ▶ Press the ENTER key to confirm.
- ▶ Press the SELECT key in order to input the third value.
- ▶ Press the ENTER key to confirm.
- ▷ The PIN is inputted. Further menu items can now be called up or changed.
- ▶ Within the Pro menu, go to the menu item Pu0.
- ▶ Press the SELECT key as often as necessary until the display shows Pu0.
- ▶ Press the ENTER key.
- ▷ The function Pu0 is selected.
- ▶ Press the SELECT key, the display will show Pul.
- ▶ Press the ENTER key.
- ▷ The display will flash twice for confirmation of the value.  
The change has been saved. The operating mode is now selected as pulse control.

If no input is made within a certain time, the program will automatically return to idle mode (Timeout).

# Lubrication system FAG CONCEPT8

**Time control** As soon as the lubrication system is supplied with voltage, it is in time control (= default setting).

A menu item is selected as follows, *Figure 18*:

- Press the SELECT key
- Confirm the selected menu item by pressing the ENTER key.

If no input is made within a certain time, the program will automatically return to idle mode (Timeout).

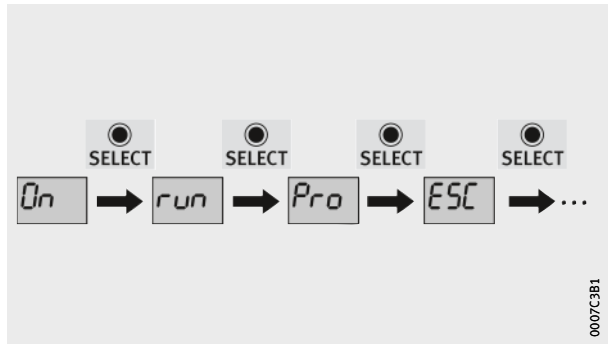

*Figure 18*

Operating mode: time control

## Functions

Display	Description of function
On	Time control Set as standard. The input is changed by pressing the SELECT key.
run	Special dispensing and back pressure checking by special dispensing: <ul style="list-style-type: none"> <li>■ For test and trial purposes, the lubricant pump fitted can be used for the delivery of small quantities of lubricant by means of a simple input or action. In this case, the pressure between the lubrication point and the lubricant pump is estimated, taking account of numerous factors. The displayed value gives an initial guide to the pressure range in bar.</li> </ul>
Pro	Program PIN protected area containing further functions
ESC	Exit the menu



**Function run** The function run can be used to select any pump body and check its function, *Figure 19*.

The function run allows:

- special dispensing
- back pressure checking.

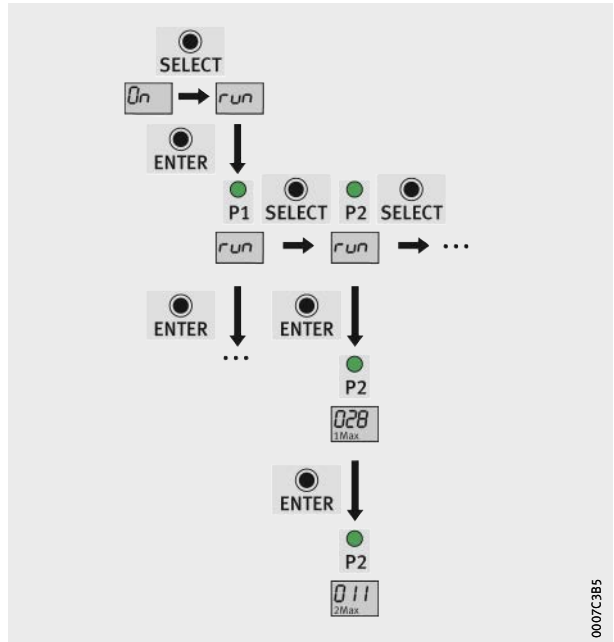

*Figure 19*  
run (special dispensing or  
back pressure checking)

A pump body is selected for special dispensing as follows:

- ▶ Press the SELECT key once in order to call up the menu item run.
- ▶ Press the ENTER key.
  - ▷ The menu item run is selected.
- ▶ Press the SELECT key in order to select the pump body.
  - ▷ The LED for the selected pump body will light.
- ▶ Press the ENTER key to carry out special dispensing.
  - ▷ The display will show the current pressure at the outlet.  
Special dispensing of lubricant will be carried out.

# Lubrication system FAG CONCEPT8

**Note** Special dispensing or back pressure checking can be carried out any number of times by pressing the ENTER key, during which the outlets of the pump body will be operated alternately.

In order to move to the next pump body, press the SELECT key or exit the menu through Timeout.

**Pro (program), menu content** Access to further, protected menu items, see *table*, is only possible by inputting a PIN.

## Submenus

Function	Description of function
PIN	Input of PIN required
Pause time, quantity	Input of pause times and lubricant quantity for pump body, observe permissible design
ESC	Exit the menu
CLr	Delete critical error messages and delete fill cycles
FIL	Bleed pump, for example at first use
PIN	Change PIN
Feedback	Change feedback (confirm each pump run)
Mode	Change operating mode: <input type="checkbox"/> Time control or pulse control

The menu item Pro is called up as follows.

- ▶ Press the SELECT key twice.
- ▷ The display will show Pro.
- ▶ Press the ENTER key.
- ▷ The menu item Pro is selected. Access to further menu items is only possible by inputting the PIN.

If no input is made within a certain time, the program will automatically return to idle mode (Timeout).

Inputting the PIN This function allows access to further functions in the menu Pro.

- Factory setting for PIN:
  - 000
- Master PIN:
  - see page 60

The PIN is inputted as follows, *Figure 20*:

- ▶ Press the SELECT key twice in order to call up the menu item Pro.
- ▷ The display will show Pro.
- ▶ Press the ENTER key.
- ▷ The menu item PIN Input is selected.
- ▶ Press the SELECT key in order to input the first value.
- ▶ Press the ENTER key to confirm.
- ▶ Press the SELECT key in order to input the second value.
- ▶ Press the ENTER key to confirm.
- ▶ Press the SELECT key in order to input the third value.
- ▶ Press the ENTER key to confirm.
- ▷ The PIN is inputted. Further menu items can now be called up or changed.

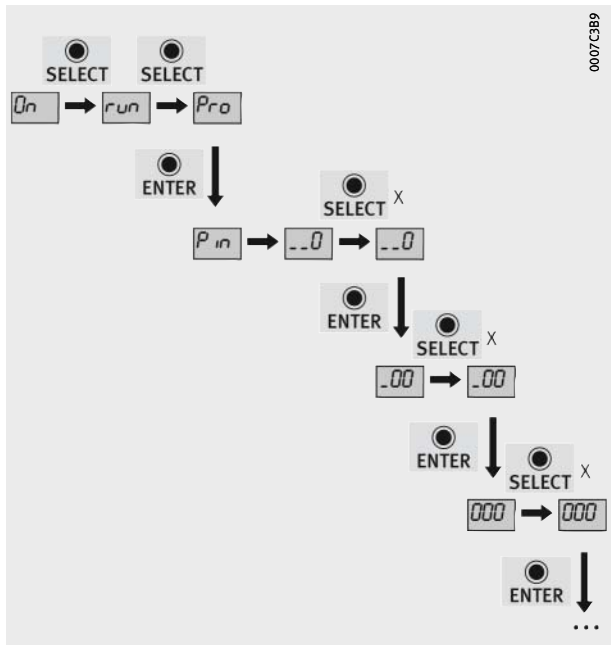

*Figure 20*  
Program Pro and inputting the PIN

# Lubrication system FAG CONCEPT8

Input of pause times and lubricant quantity This function can be used to input the pause times (TIME) and lubricant quantity (CYCLE) for each individual pump body.

## Functions

Key	Description	Value	Unit
TIME	Set the pause time for each pump body = time between lubrication operations in h	1 – 240	h
CYCLE	Set the delivery strokes for each pump body = number of delivery strokes per operation 1 delivery stroke = 0,15 cm <sup>3</sup>	1 – 96	–

A pump body is a piston pump with two outlets that are operated alternately and dispense identical quantities. The pump bodies can be switched off using the setting CYCLE = 0.

## Examples

- CYCLE 1 means:
  - In each operation, the pump body carries out 1 delivery stroke, either at outlet 1 or at outlet 2, depending on the piston position of the two pistons.
- CYCLE 2 means:
  - In each operation, the pump body carries out 2 delivery strokes, one delivery stroke at 1 and one delivery stroke at outlet 2. Depending on the piston position, the first delivery stroke starts at outlet 1 or 2.

## Default setting

Default setting for each pump body fitted:

- TIME = 4 h
- CYCLE = 1.

**Inputting the pause time and lubricant quantity**

The pause time is inputted in the menu Pro as follows, *Figure 21*:

- ▶ Select the pump body by pressing the SELECT key.
  - ▷ The LED of the selected pump body will light and the pump will be shown on the control panel.
- ▶ Press the ENTER key.
  - ▷ The LED TIME (pause time) will light.
- ▶ Press the SELECT key as often as necessary until the required pause time appears. The maximum pause time is 240 h.
  - ▷ Press the ENTER key.
  - ▷ The display will flash twice for confirmation. The pause time is inputted.
  - ▷ The LED CYCLE (number of delivery strokes) will light.
- ▶ Press the SELECT key as often as necessary until the display shows the required lubricant quantity. The maximum lubricant quantity is 96 delivery strokes per time interval.
  - ▷ Press the ENTER key.
  - ▷ The display will flash twice for confirmation. The lubricant quantity is inputted.

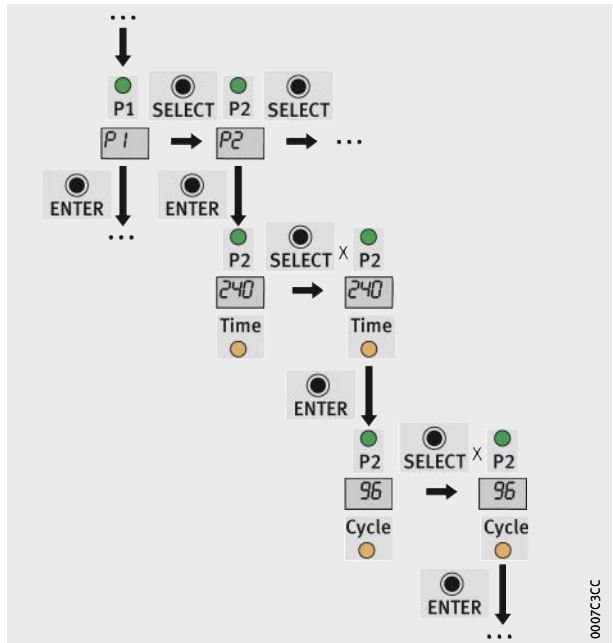

*Figure 21*  
Inputting pause times and lubricant quantity

0007C3CC

# Lubrication system FAG CONCEPT8

**Note** The lubrication system FAG CONCEPT8 is designed for minimal quantity lubrication. A comparison value is calculated from the inputs for pause time and lubricant quantity. If this value is too high, the effective life of the lubrication system will be reduced.

A warning is given as follows, *Figure 22*:

- The LEDs TIME and CYCLE flash alternately on the control panel
- The LED ALARM lights
- INF (information) is shown for 10 s on the display.



During the 10 s, operation of the lubrication system is blocked.

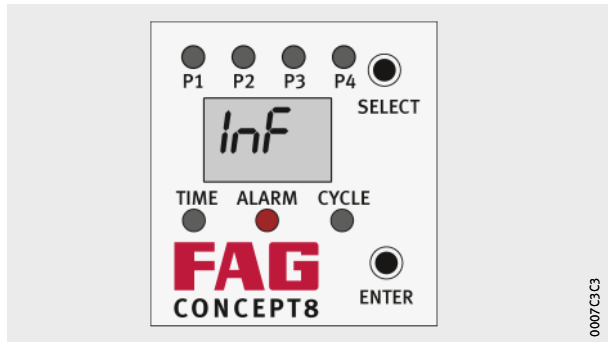

*Figure 22*

Warning of excessive value



At low temperatures (temperatures  $< 0^{\circ}\text{C}$ ) small lubricant quantities (lubrication operation max. 3 cycles) in conjunction with shorter pause times are recommended.

- Function ESC This function is used to exit the menu Pro.  
The menu Pro is exited as follows, *Figure 23*:
- ▶ Press the SELECT key as often as necessary until the display shows ESC.
  - ▶ Press the ENTER key.
  - ▷ The menu is exited.

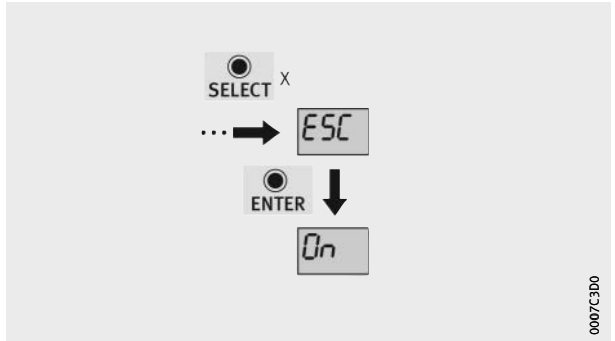

*Figure 23*  
Function ESC

0007C3D0

# Lubrication system FAG CONCEPT8

**Function CLR** This function can be used to delete critical error messages and end fill cycles prematurely. For an overview of possible error messages, see *table*, page 60.

The error messages occurring in the menu Pro are deleted as follows, *Figure 24*:

- ▶ Press the SELECT key as often as necessary until the display shows CLR.
- ▶ Press the ENTER key.
- ▷ The error messages have been deleted or the fill cycle has been ended.



For reasons of functional safety, no inputs can be made using the action pin while the pump motors are running. Even if external control by means of a PLC is used, no inputs will be recognised during this time.

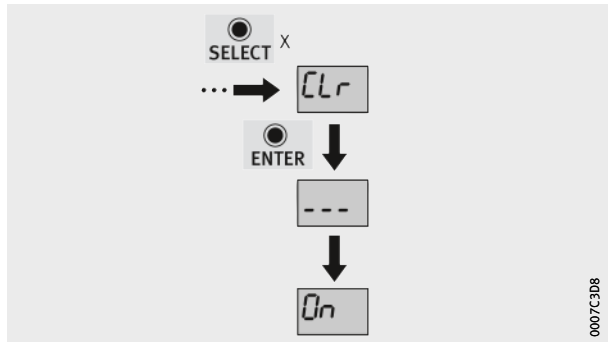

*Figure 24*  
Function CLR



Function FIL This function is required for:

- initial commissioning
- bleeding of the pump.

When the function FIL is called up, the relevant pump body becomes active 15 times per outlet. The total time for carrying out the function FIL once is approx. 5 min per pump body.

The function FIL can be terminated using the menu item CLr. Termination is only possible between delivery strokes.

**Note** The lubrication system FAG CONCEPT8 must be bled when it is operated for the first time. Each pump body fitted and activated must be bled separately. The operation is complete as soon as lubricant emerges from the outlet. It may be necessary to carry out the function FIL several times until lubricant emerges.

The function FIL is called up in the menu Pro as follows, *Figure 25*, page 40:

- ▶ Press the SELECT key as often as necessary until the display shows FIL.
- ▶ Press the ENTER key.
- ▷ The function FIL is selected.
- ▷ The LED for pump 1 will light. The display shows FIL.
- ▶ Press the ENTER key.
- ▷ The pump will be bled.

Repeat the steps described for bleeding of the other pump bodies.

# Lubrication system FAG CONCEPT8

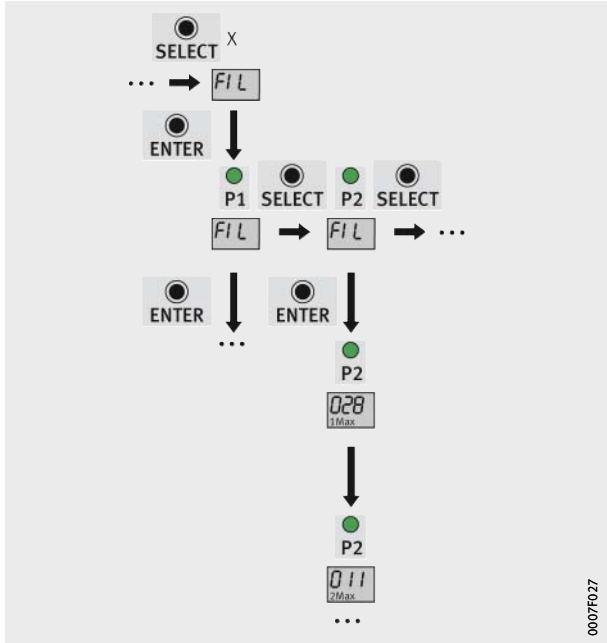

Figure 25  
Function FIL

## Changing the PIN

### Note

The factory setting of the PIN is 000, see page 60.

The PIN can be changed in the menu Pro as follows, *Figure 26*:

- ▶ Press the SELECT key as often as necessary until the display shows PIN.
  - ▶ Press the ENTER key.
  - ▶ Press the SELECT key in order to change the first value.
  - ▶ Press the ENTER key to confirm.
  - ▶ Press the SELECT key in order to change the second value.
  - ▶ Press the ENTER key to confirm.
  - ▶ Press the SELECT key in order to change the third value.
  - ▶ Press the ENTER key to confirm.
- ▷ The display will flash twice for confirmation of the value.  
The changed PIN has been saved.

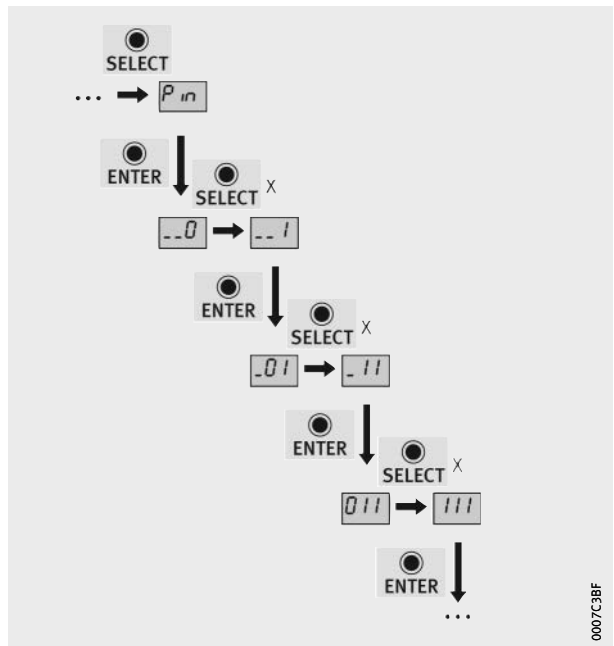

*Figure 26*  
Example of new PIN: 111

# Lubrication system FAG CONCEPT8

**Feedback** This function can be used to change the setting for motor run control (confirming lubrication), see *table*.

## Settings

Display	Description	
F1	Feedback switched on	Default setting
F0	Feedback switched off	Alternative

Feedback = motor run control:

- After activation of the outlets, the output signal at PIN 4 for the time of the actual motor run (max. 20 s per outlet) is switched from HIGH to LOW (0 V).

The number of confirmed motor runs can be used to estimate depletion (1 motor run = 1 pump stroke = 0,15 cm<sup>3</sup>).

If the feedback function is switched off (F0), the output signal at PIN 4 is permanently HIGH if the pump is operating correctly.

The function is called up in the menu Pro as follows, *Figure 27*:

- ▶ Press the SELECT key as often as necessary until the display shows F1.
- ▶ Press the ENTER key.
- ▶ Press the SELECT key until the display shows F0.
- ▶ Press the ENTER key.
- ▷ The display will flash twice for confirmation of the value. The change has been saved. The function Feedback is switched off.

If no input is made within a certain time, the program will automatically return to idle mode (Timeout).

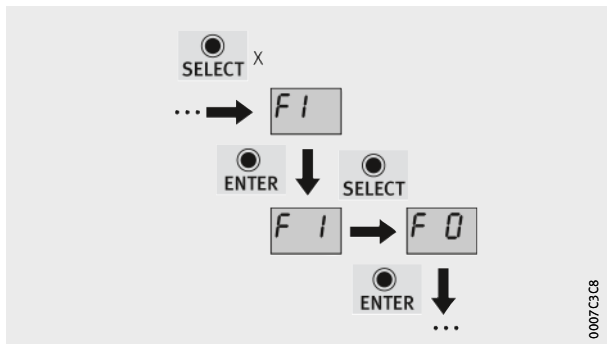

*Figure 27*  
Changing feedback

Mode This function is used to change the operating mode between time control and pulse control, *Figure 28*.

**Settings**

Display	Description	
Pu0	Time control switched on, pulse control switched off. On is displayed and the activated pump bodies flash in sequence (green LED).	Default setting
Pu1	Pulse control switched on, time control switched off. PAU is displayed and the fitted pump bodies flash in sequence (green LED).	Alternative

On = time control  
(4 activated pump bodies)  
PAU = pulse control  
(4 fitted pump bodies)

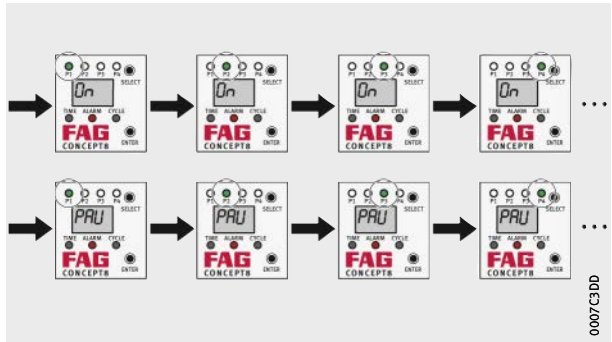

*Figure 28*  
Examples of operating modes

The function is called up in the menu Pro as follows, *Figure 29*, page 44:

- ▶ Press the SELECT key as often as necessary until the display shows Pu0.
- ▶ Press the ENTER key.
- ▶ Press the SELECT key.
- ▷ The display shows Pu1.
- ▶ Press the ENTER key.
- ▷ The display will flash twice for confirmation of the value.  
The change has been saved. The operating mode is now selected as pulse control.

If no input is made within a certain time, the program will automatically return to idle mode (Timeout).

# Lubrication system FAG CONCEPT8

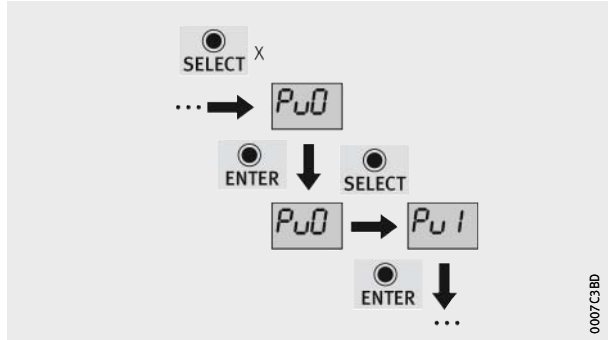

Figure 29  
Changing the operating mode

## Pulse control

A menu item is selected as follows, Figure 30:

- press the SELECT key
- confirm the selected menu item by pressing the ENTER key.

If no input is made within a certain time, the program will automatically return to idle mode (Timeout).

## Functions

Display	Description of function
PAU	Pulse control Time control is set as standard. The input is changed by pressing the SELECT key.
Pro	Program PIN protected area containing further functions.
ESC	Exit the menu

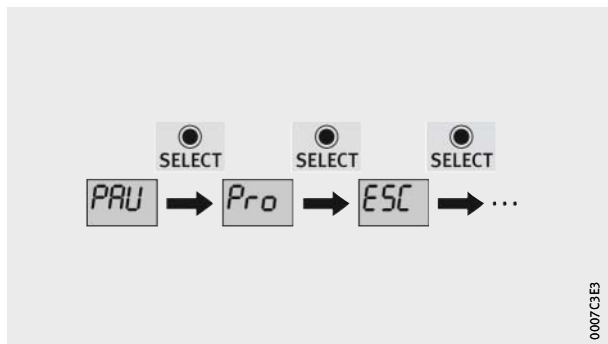

Figure 30  
Pulse control

**Pro (program), menu content** Access to further, protected menu items is only possible by inputting a PIN, see *table*.

The menu item Pro is called up as follows.

▶ Press the SELECT key once.

▷ The display will show Pro.

▶ Press the ENTER key.

▷ The menu item Pro is selected. Access to further menu items is only possible by inputting the PIN.

If no input is made within a certain time, the program will automatically return to idle mode (Timeout).

#### Submenus

Function	Description of function
PIN	Input of PIN required
CLr	Delete critical error messages and delete fill cycles
FIL	Bleed pump, for example at first use
PIN	Change PIN
Feedback	Change feedback (confirm each pump run)
Mode	Change of operating mode: ■ time control or pulse control
ESC	Exit the menu

**Inputting the PIN** This function allows access to further functions in the menu Pro.

■ Factory setting for PIN:

– 000

■ Master PIN:

– see page 60.

# Lubrication system FAG CONCEPT8

The PIN is inputted as follows, *Figure 31*:

- ▶ Press the SELECT key once in order to call up the menu item Pro.
- ▷ The display will show Pro.
- ▶ Press the ENTER key.
- ▷ The menu item PIN Input is selected.
- ▶ Press the SELECT key in order to input the first value.
- ▶ Press the ENTER key to confirm.
- ▶ Press the SELECT key in order to input the second value.
- ▶ Press the ENTER key to confirm.
- ▶ Press the SELECT key in order to input the third value.
- ▶ Press the ENTER key to confirm.
- ▷ The PIN is inputted. Further menu items can now be called up or changed.

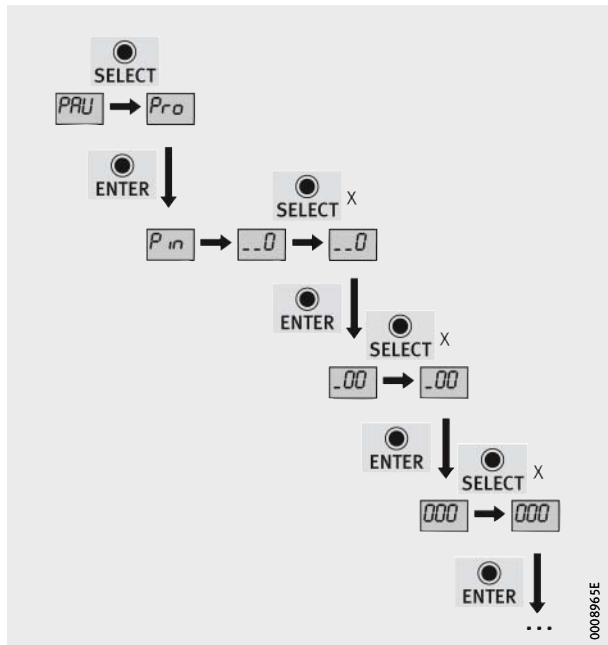

*Figure 31*  
Program Pro and inputting the PIN



**Function CLR** This function can be used to delete critical error messages and end fill cycles prematurely. For an overview of possible error messages, see *table*, page 60.

The error messages occurring in the menu Pro are deleted as follows, *Figure 32*:

- ▶ Press the SELECT key as often as necessary until the display shows CLR.
- ▶ Press the ENTER key.
- ▷ The error messages have been deleted or the fill cycle has been ended.



For reasons of functional safety, no inputs can be made using the action pin while the pump motors are running. Even if external control by means of a PLC is used, no inputs will be recognised during this time.

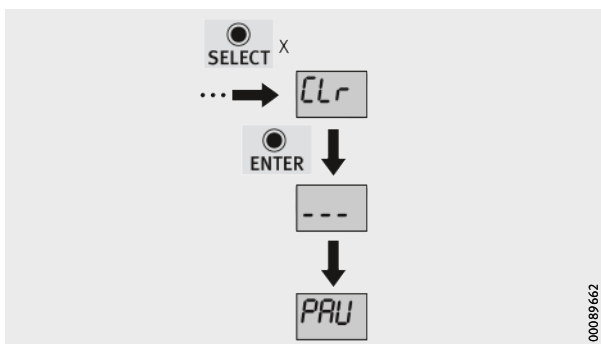

*Figure 32*  
Function CLR

**Function FIL** This function is required for:

- initial commissioning
- bleeding of the pump.

When the function FIL is called up, the relevant pump body becomes active 15 times per outlet. The total time for carrying out the function FIL once is approx. 5 min per pump body.

The function FIL can be terminated using the menu item CLR. Termination is only possible between delivery strokes.

# Lubrication system FAG CONCEPT8

**Note** The lubrication system FAG CONCEPT8 must be bled when it is operated for the first time. Each pump body fitted and activated must be bled separately. The operation is complete as soon as lubricant emerges from the outlet. It may be necessary to carry out the function FIL several times until lubricant emerges.

The function FIL is called up in the menu Pro as follows, *Figure 33*:

- ▶ Press the SELECT key as often as necessary until the display shows FIL.
- ▶ Press the ENTER key.
- ▷ The function FIL is selected.
- ▷ The LED for pump 1 will light. The display shows FIL.
- ▶ Press the ENTER key.
- ▷ The pump will be bled.

Repeat the steps described for bleeding of the other pump bodies.

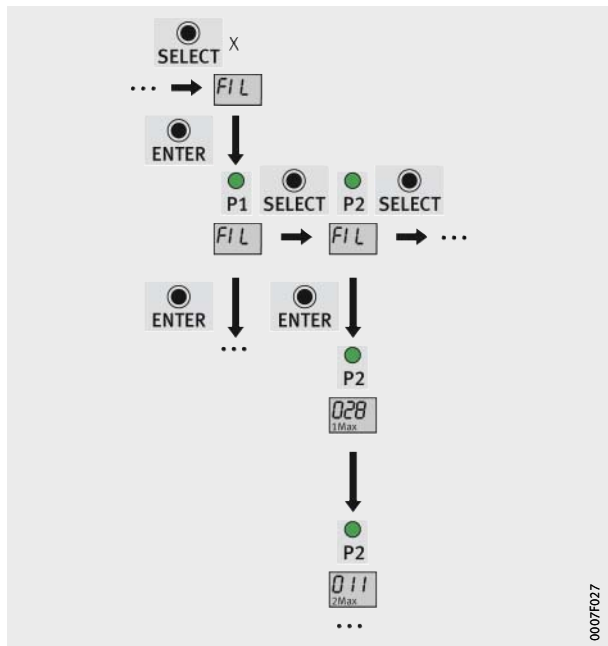

*Figure 33*  
Function FIL

0007F027

## Changing the PIN

The factory setting of the PIN is 000, see page 60.

The PIN can be changed in the menu Pro as follows, *Figure 34*:

- ▶ Press the SELECT key as often as necessary until the display shows PIN.
- ▶ Press the ENTER key.
- ▶ Press the SELECT key in order to change the first value.
- ▶ Press the ENTER key to confirm.
- ▶ Press the SELECT key in order to change the second value.
- ▶ Press the ENTER key to confirm.
- ▶ Press the SELECT key in order to change the third value.
- ▶ Press the ENTER key to confirm.
- ▷ The display will flash twice for confirmation of the value.  
The changed PIN has been saved.

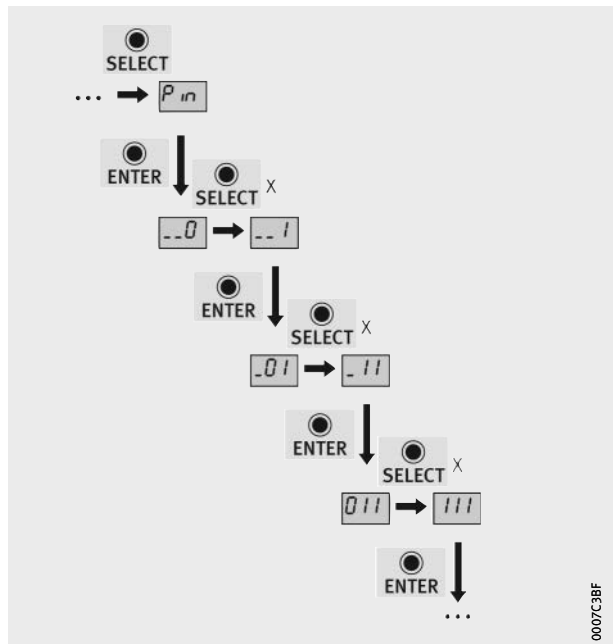

*Figure 34*  
Example of new PIN: 111

0007C3BF

# Lubrication system FAG CONCEPT8

**Feedback** This function can be used to change the setting for motor run control (confirming lubrication), see *table*.

## Settings

Display	Description	
F1	Feedback switched on	Default setting
F0	Feedback switched off	Alternative

Feedback = motor run control:

■ After activation of the outlets, the output signal at PIN 4 for the time of the actual motor run (max. 20 s per outlet) is switched from HIGH to LOW (0 V).

The number of confirmed motor runs can be used to estimate depletion (1 motor run = 1 pump stroke = 0,15 cm<sup>3</sup>).

If the feedback function is switched off (F0), the output signal at PIN 4 is permanently HIGH if the pump is operating correctly.

The function is called up in the menu Pro as follows, *Figure 35*:

- ▶ Press the SELECT key as often as necessary until the display shows F1.
- ▶ Press the ENTER key.
- ▶ Press the SELECT key until the display shows F0.
- ▶ Press the ENTER key.
- ▷ The display will flash twice for confirmation of the value. The change has been saved. The function Feedback is switched off.

If no input is made within a certain time, the program will automatically return to idle mode (Timeout).

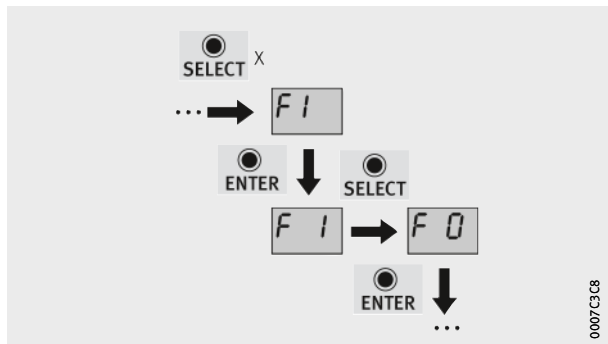

*Figure 35*  
Changing feedback

Mode This function is used to change the operating mode between time control and pulse control, *Figure 36*.

**Settings**

Display	Description	
Pu0	Time control switched on, pulse control switched off. On is displayed and the activated pump bodies flash in sequence (green LED).	Default setting
Pu1	Pulse control switched on, time control switched off. PAU is displayed and the fitted pump bodies flash in sequence (green LED).	Alternative

On = time control  
(4 activated pump bodies)  
PAU = pulse control  
(4 fitted pump bodies)

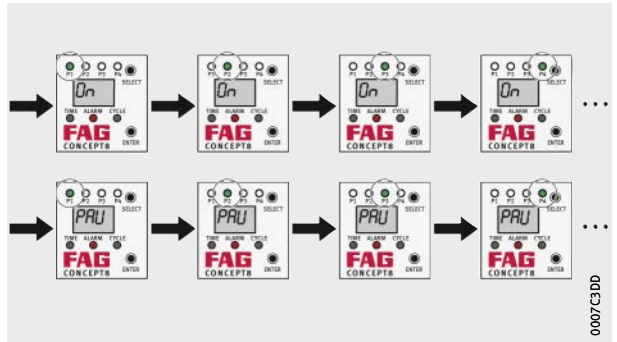

*Figure 36*

Examples of operating modes

The function is called up in the menu Pro as follows, *Figure 37*, page 52:

- ▶ Press the SELECT key as often as necessary until the display shows Pu0.
- ▶ Press the ENTER key.
- ▶ Press the SELECT key.
- ▷ The display shows Pu1.
- ▶ Press the ENTER key.
- ▷ The display will flash twice for confirmation of the value.  
The change has been saved. The operating mode is now selected as pulse control.

If no input is made within a certain time, the program will automatically return to idle mode (Timeout).

# Lubrication system FAG CONCEPT8

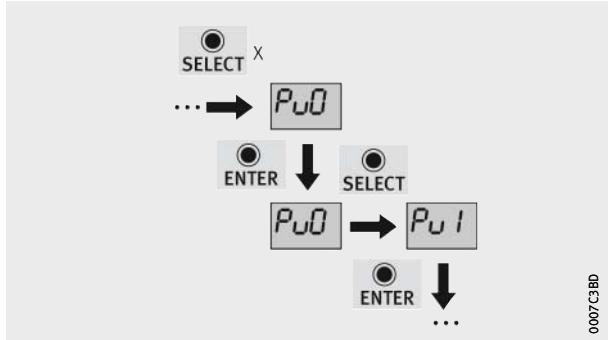

*Figure 37*  
Changing the operating mode

Function ESC

This function is used to exit the menu Pro.

The menu Pro is exited as follows, *Figure 38*:

- ▶ Press the SELECT key as often as necessary until the display shows ESC.
- ▶ Press the ENTER key.
- ▷ The menu is exited.

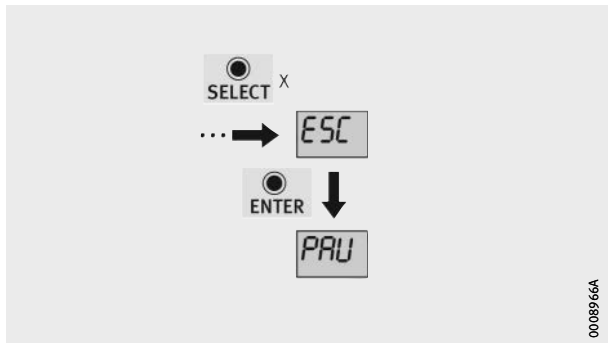

*Figure 38*  
Function ESC

**Pulse signals  
for controlling the outlets**

Pulse signals for controlling the outlets:

- are stated in seconds
- have an accuracy of  $\pm 0,2$  s
- have a pause time between 2 pulses of:  $>30$  s.

**Note**

While pulse signals are present at input PIN 2, the display "PAU" will flash for the duration of the pulse length. The LEDs for display of the pump bodies are not active at this time.



The lubrication system FAG CONCEPT8 is designed for minimal quantity lubrication. Further information is given on page 65.

# Lubrication system FAG CONCEPT8

Pump body 1 –  
outlet 1 or outlet 2

Control of pump body 1, *Figure 39*:

- Lubricant quantity per pulse:
  - 0,15 cm<sup>3</sup>
- Pulse length:
  - 2 s
- Start of dispensing:
  - outlet 1 or outlet 2
- The outlets are addressed alternately.

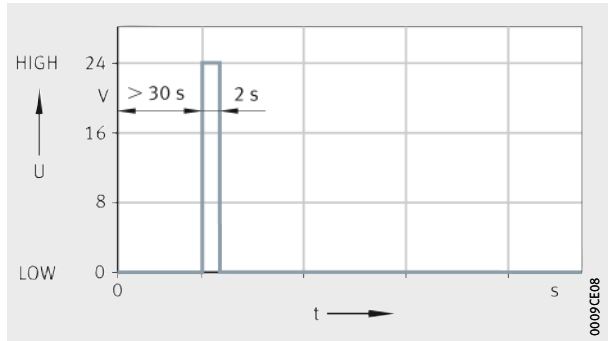

*Figure 39*

Pump body 1 –  
outlet 1 or outlet 2

Pump body 1 –  
outlet 1 and outlet 2

Control of pump body 1, *Figure 40*:

- Lubricant quantity per pulse:
  - 0,15 cm<sup>3</sup>
- Pulse length:
  - 2 s
- Pause time between 2 pulses:
  - >30 s
- Start of dispensing:
  - outlet 1 or outlet 2
- The outlets are addressed alternately.

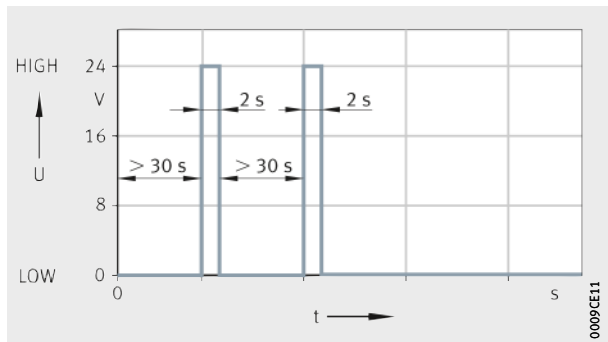

*Figure 40*

Pump body 1 –  
outlet 1 and outlet 2



Pump body 2 –  
outlet 1 or outlet 2

Control of pump body 2, *Figure 41:*

- Lubricant quantity per pulse:
  - 0,15 cm<sup>3</sup>
- Pulse length:
  - 4 s
- Start of dispensing:
  - outlet 1 or outlet 2
- The outlets are addressed alternately.

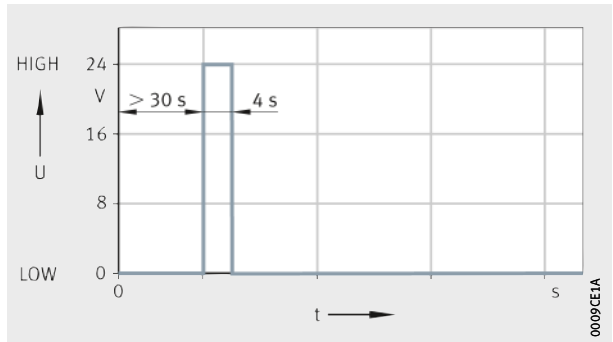

*Figure 41*

Pump body 2 –  
outlet 1 or outlet 2

Pump body 2 –  
outlet 1 and outlet 2

Control of pump body 2, *Figure 42:*

- Lubricant quantity per pulse:
  - 0,15 cm<sup>3</sup>
- Pulse length:
  - 4 s
- Pause time between 2 pulses:
  - >30 s
- Start of dispensing:
  - outlet 1 or outlet 2
- The outlets are addressed alternately.

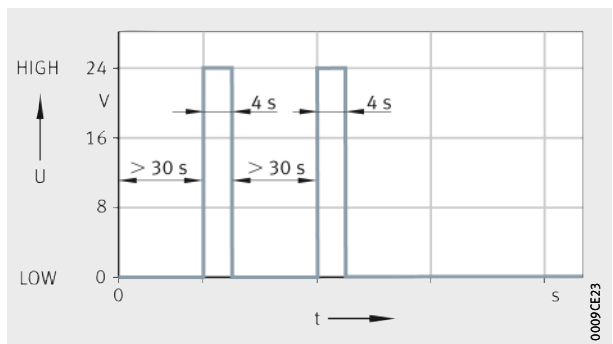

*Figure 42*

Pump body 2 –  
outlet 1 and outlet 2

# Lubrication system FAG CONCEPT8

Pump body 3 –  
outlet 1 or outlet 2

Control of pump body 3, *Figure 43*:

- Lubricant quantity per pulse:
  - 0,15 cm<sup>3</sup>
- Pulse length:
  - 6 s
- Start of dispensing:
  - outlet 1 or outlet 2
- The outlets are addressed alternately.

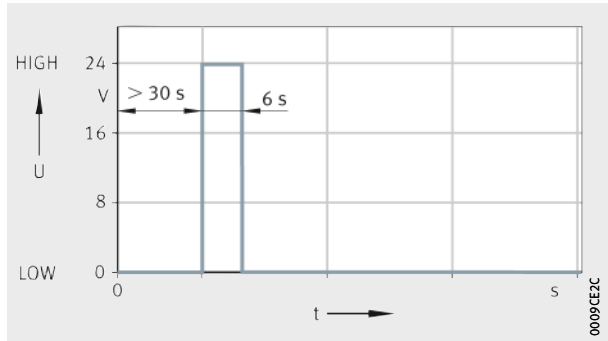

*Figure 43*

Pump body 3 –  
outlet 1 or outlet 2

Pump body 3 –  
outlet 1 and outlet 2

Control of pump body 3, *Figure 44*:

- Lubricant quantity per pulse:
  - 0,15 cm<sup>3</sup>
- Pulse length:
  - 6 s
- Pause time between 2 pulses:
  - >30 s
- Start of dispensing:
  - outlet 1 or outlet 2
- The outlets are addressed alternately.

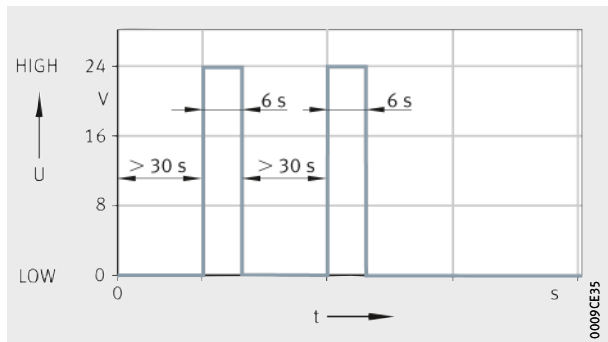

*Figure 44*

Pump body 3 –  
outlet 1 and outlet 2

Pump body 4 –  
outlet 1 or outlet 2

Control of pump body 4, *Figure 45:*

- Lubricant quantity per pulse:
  - 0,15 cm<sup>3</sup>
- Pulse length:
  - 8 s
- Start of dispensing:
  - outlet 1 or outlet 2
- The outlets are addressed alternately.

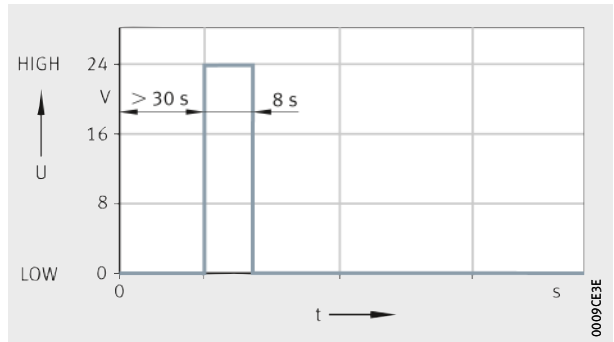

*Figure 45*

Pump body 4 –  
outlet 1 or outlet 2

Pump body 4 –  
outlet 1 and outlet 2

Control of pump body 4, *Figure 46:*

- Lubricant quantity per pulse:
  - 0,15 cm<sup>3</sup>
- Pulse length:
  - 8 s
- Pause time between 2 pulses:
  - >30 s
- Start of dispensing:
  - outlet 1 or outlet 2
- The outlets are addressed alternately.

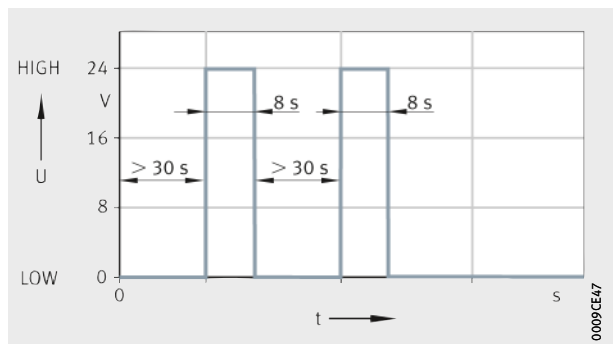

*Figure 46*

Pump body 4 –  
outlet 1 and outlet 2

# Lubrication system FAG CONCEPT8

**Note** If the feedback signal (F 1 = feedback in function) is evaluated, a new pulse signal can be started earlier. The precondition is as follows:

- After the end of the motor run, a HIGH signal must be present at PIN 4 for 3 s.



At low temperatures (temperatures  $<0\text{ }^{\circ}\text{C}$ ), small lubricant quantities (lubrication operation max. 3 cycles) in conjunction with shorter pause times are recommended.

## Output signals at PIN 4

The possible output signals that may be present at PIN 4 are shown in *Figure 47* to *Figure 51*.

These signals can be used for diagnosis of the operating status of the lubrication system FAG CONCEPT8.

- ① Input signal (PIN 2)
- ② Output signal with activated feedback function (PIN 4)
- ③ Max. 20 s motor run

*Figure 47*

Control of pump body 1

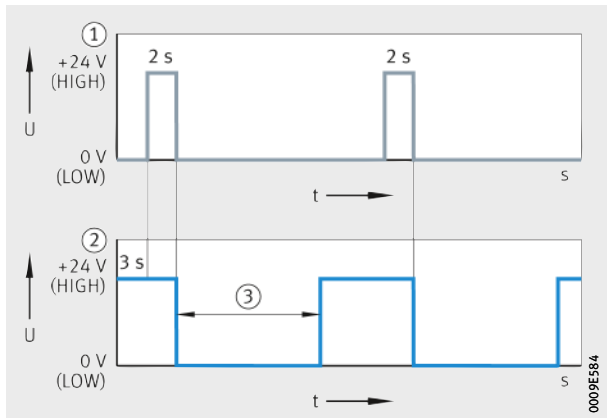

- ① Input signal (PIN 2)
- ② Output signal with activated feedback function (PIN 4)
- ③ Max. 20 s motor run

*Figure 48*

Control of pump body 2

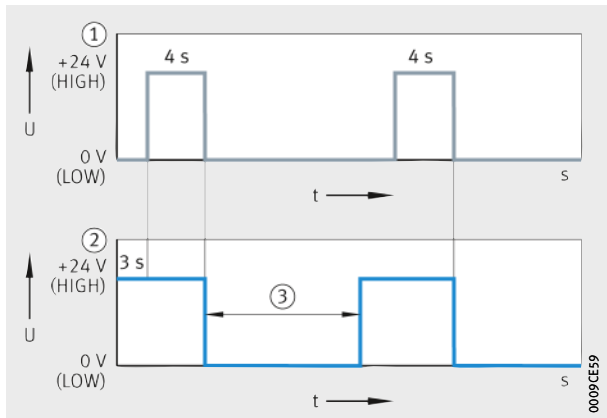

- ① Input signal (PIN 2)
- ② Output signal with activated feedback function (PIN 4)
- ③ Max. 20 s motor run

Figure 49  
Control of pump body 3

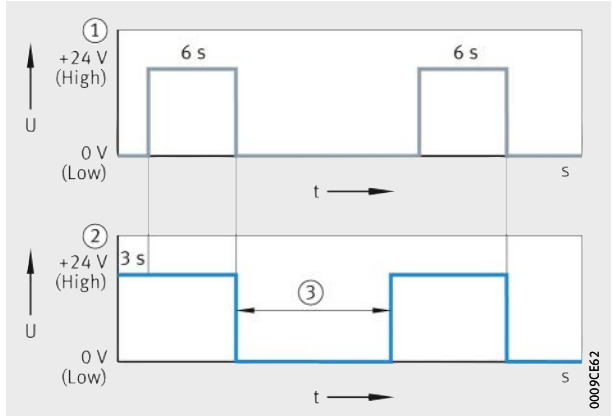

- ① Input signal (PIN 2)
- ② Output signal with activated feedback function (PIN 4)
- ③ Max. 20 s motor run

Figure 50  
Control of pump body 4

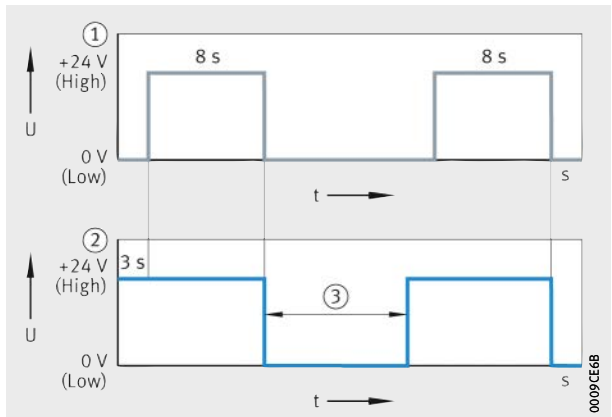

- ① Output signal (PIN 4)
- ② Error or malfunction detected

Figure 51  
Errors E1 to E8

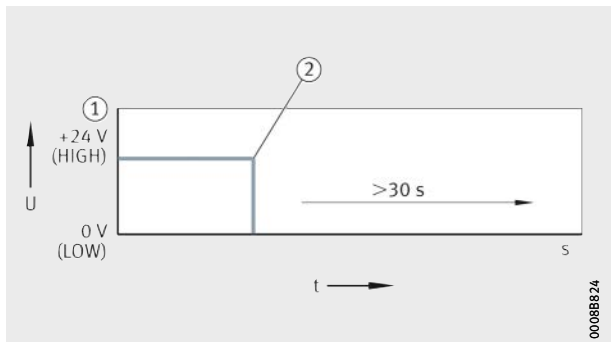

# Lubrication system FAG CONCEPT8

**Master PIN** The master PIN is 321.  
The master PIN gives access to the program Pro.

**Troubleshooting and rectification** This chapter describes the error messages and malfunction messages as well as their remedy, see *table*.

If an error occurs in a pump body, this is indicated by the LEDs P1 to P4 on the control panel.

If time control is used, all the activated pump body LEDs will flash in sequence while, if pulse control is used, all the fitted pump body LEDs will flash in sequence.

## Error messages

Error	Description
E1	Empty level display
E2	Original cartridge missing
E3	Pump body motor too slow
E4	Internal electrical defect
E5	Not assigned
E6	Not assigned
E7	Back pressure too high
E8	Not assigned

**E1 – Empty level display** Output signal PIN 4 = LOW (0 V), *Figure 52.*

**Error E1**

Display and control panel	Cause	Remedy
<ul style="list-style-type: none"> <li>■ LED ALARM</li> <li>■ Display: E1</li> </ul>	The cartridge is empty. The pump function of all pump bodies has been stopped.	Insert new original cartridge. The error message will be cancelled automatically.

- ① Display: Error E1
- ② ALARM (red LED)

*Figure 52*

Display: Error E1

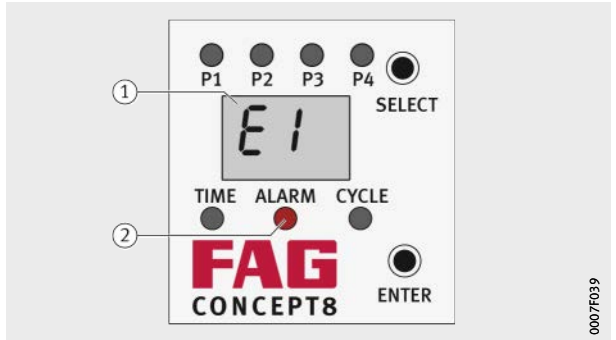

0007F039

**E2 – Original cartridge missing** Output signal PIN 4 = LOW (0 V), *Figure 53.*

**Error E2**

Display and control panel	Cause	Remedy
<ul style="list-style-type: none"> <li>■ LED ALARM</li> <li>■ Display: E2</li> </ul>	The original cartridge is missing. The pump function of all pump bodies has been stopped.	Insert new original cartridge. The error message will be cancelled automatically.

- ① Display: Error E2
- ② ALARM (red LED)

*Figure 53*

Display: Error E2

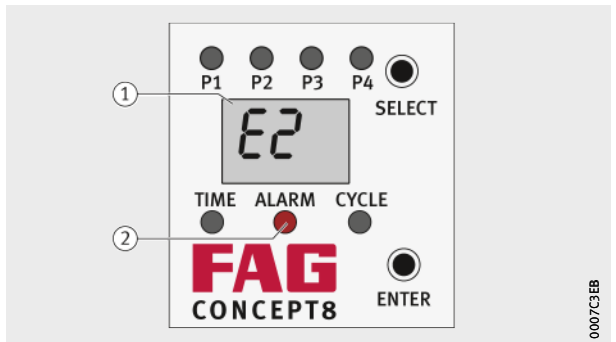

0007C3EB

# Lubrication system FAG CONCEPT8

**E3 – Pump body motor too slow** Output signal PIN 4 = LOW (0 V), *Figure 54* and *Figure 55*.

**Error E3**

Display and control panel	Cause	Remedy
<ul style="list-style-type: none"> <li>■ LED ALARM</li> <li>■ Display of pump body (in this case P2)</li> <li>■ Display: 2E3</li> </ul>	<p>Undervoltage. The pump body motor does not achieve the shutdown current within a specified time.</p> <p>The pump function of the affected pump body has been stopped.</p>	<p>Eliminate the cause.</p> <p>Delete the error in the program Pro using CLR or interrupt the voltage supply for a brief period.</p> <p>The pump will restart.</p>

- ① Defective pump body (green LED)
- ② Display: Error 2E3
- ③ ALARM (red LED)

*Figure 54*  
Display: Error 2E3



0007C3EF

- On = time control (4 activated pump bodies)
- PAU = pulse control (4 fitted pump bodies)

*Figure 55*  
Example

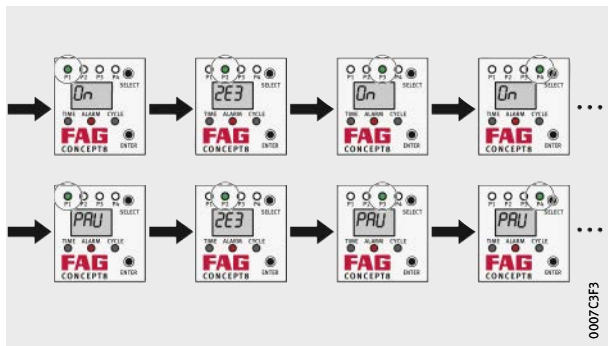

0007C3F3



**E4 – Internal electrical defect** Output signal PIN 4 = LOW (0 V), *Figure 56 and Figure 57.*

**Error E4**

Display and control panel	Cause	Remedy
<ul style="list-style-type: none"> <li>■ LED ALARM</li> <li>■ Display of pump body (in this case P2)</li> <li>■ Display: 2E4</li> </ul>	Internal electrical defect. The pump function of the affected pump body has been stopped.	Delete the error in the program Pro using CLR or interrupt the voltage supply for a brief period. The pump will restart. If this occurs again, log the pump for inspection.

- ① Defective pump body (green LED)
- ② Display: Error 2E4
- ③ ALARM (red LED)

*Figure 56*  
Display: Error E4



0007C3F9

- On = time control  
(4 activated pump bodies)
- PAU = pulse control  
(4 fitted pump bodies)

*Figure 57*  
Example

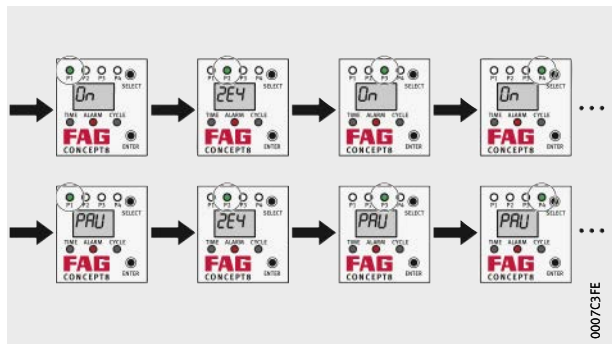

0007C3FE

**E5** Not assigned

**E6** Not assigned

# Lubrication system FAG CONCEPT8

**E7 – Back pressure too high** Output signal PIN 4 = LOW (0 V), *Figure 58* and *Figure 59*.

**Error E7**

Display and control panel	Cause	Remedy
<ul style="list-style-type: none"> <li>■ LED ALARM</li> <li>■ Display of pump body (in this case P2)</li> <li>■ Display: 2E7</li> </ul>	<p>The back pressure was three times too high as a result. The pump function of the affected pump body has been stopped.</p> <p>Possible errors:</p> <ul style="list-style-type: none"> <li>■ the lubrication point is blocked</li> <li>■ the hose length was too long</li> <li>■ the grease is too hard or too stiff.</li> </ul>	<p>Eliminate the cause of the high back pressure (&gt;70 bar). Delete the error in the program Pro using CLR or interrupt the voltage supply for a brief period. The pump will restart.</p>

- ① Defective pump body (green LED)
- ② Display: Error 2E7
- ③ ALARM (red LED)

*Figure 58*  
Display: Error E7



0007C403

- On = time control  
(4 activated pump bodies)
- PAU = pulse control  
(4 fitted pump bodies)

*Figure 59*  
Example

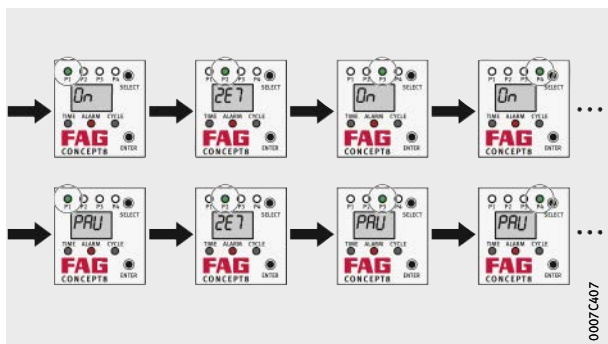

0007C407

**E8** Not assigned

## Maintenance

The lubrication system FAG CONCEPT8 is designed for minimal quantity lubrication. Each of the pump elements is designed for 130 000 delivery strokes. 130 000 delivery strokes correspond to the delivery of approx. 19 500 cm<sup>3</sup> of lubricant.

The following maintenance work must be carried out by the site operator:

- regular readout of the device memory
- changing of cartridges.

## Device memory readout

Reading out the device memory can be used to determine the number of delivery strokes. In idle mode, the display shows On or PAU.

The number of delivery strokes can be read out as follows, *Figure 60*:

- ▶ Remove the action pin from the upper housing part.
- ▶ With the action pin, press the ENTER key for 5 s.
- ▷ The display will show, consecutively, the number of delivery strokes for the fitted pump bodies P1, P2, P3 and P4.

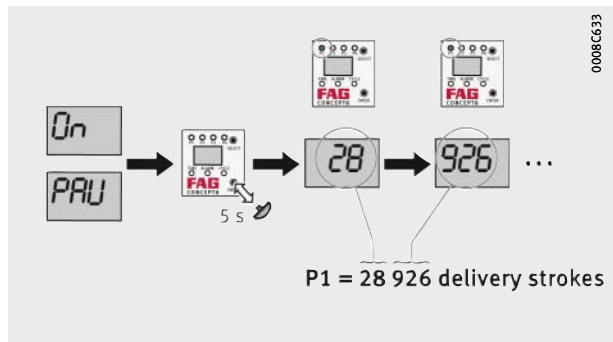

*Figure 60*  
Determining the number  
of delivery strokes

# Lubrication system FAG CONCEPT8

**Note** The number of delivery strokes is counted up to 65 535. This is followed by a rollover indicated by 1 in the display, which means that the number displayed must be increased by 65 535 to give the actual value, *Figure 61*. Service of the pump bodies after 130 000 delivery strokes is urgently recommended in order to ensure the performance capability of the lubrication system.

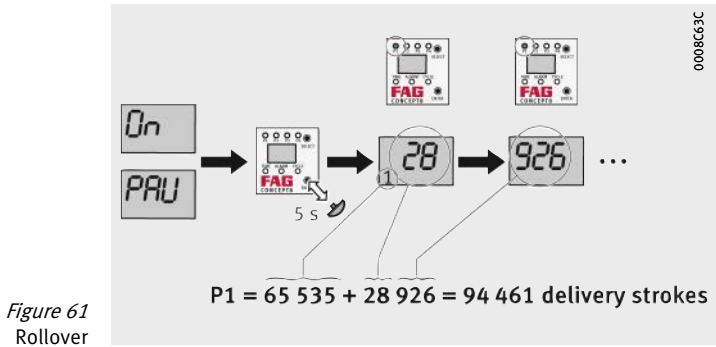

Figure 61  
Rollover

A more extensive service, except for replacement of the cartridge, is not necessary.

**Replacing the cartridge** When replacing the cartridge, the depleted cartridges must be disposed of in accordance with the appropriate safety datasheets from the lubricant manufacturer.

The depleted cartridges contain residues of lubricant and must be disposed of together with waste materials containing oil.

**NOTICE**

The upper housing part is preloaded. Risk of injury due to parts springing off when opening the upper housing part. Carefully loosen the collar ring and upper housing part. <

The empty cartridge is replaced as follows, *Figure 62*, page 68:

- ▶ Rotate the collar ring on the upper housing part anticlockwise.
- ▶ Carefully remove the upper housing part.
- ▶ Remove the lubricant cartridge by rotating it one quarter of a revolution anticlockwise.
- ▶ Lift off the empty cartridge.
- ▶ Remove the retaining cover of the new cartridge.
- ▶ Insert the cartridge by rotating it clockwise. Ensure that the stud engages in the slot in the lower part.
- ▶ Position the upper housing part under light pressure and tighten the collar ring finger tight until it stops.
- ▷ The error message shown will be cancelled automatically.
- ▶ Bleed the system as necessary.
- ▷ The lubrication system is now ready for operation.

# Lubrication system FAG CONCEPT8

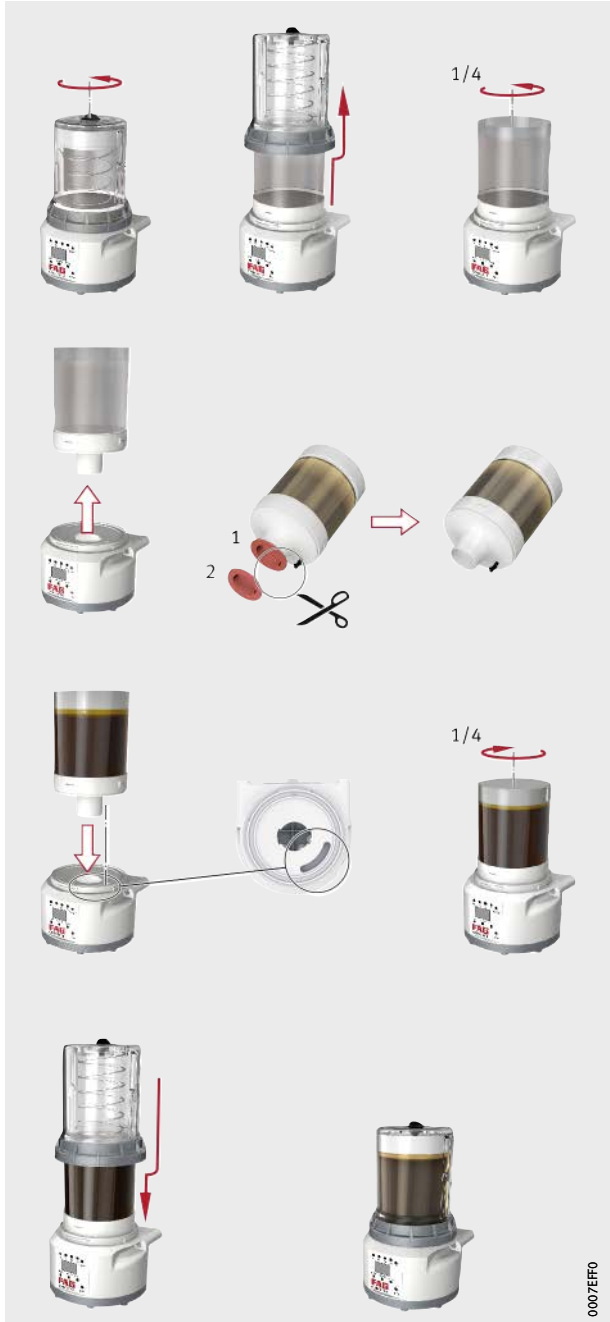

Figure 62  
Replacing the cartridge

0007EFO

**Service** When the lubrication system FAG CONCEPT8 reaches 130 000 delivery strokes, general overhaul is available from Schaeffler Service. At this time, the worn functional parts are replaced. As a result, a lubrication system equivalent to new condition with a further 130 000 delivery strokes per pump body is available. Please request a corresponding quotation as necessary.

**Decommissioning** In decommissioning, the following must be observed:

- The machine must be shut down.
- The whole installation must be placed in a voltage-free state.
- The lubrication system must be in a voltage-free state.
- The lubricant pipes must be in an unpressurised state.

**Disposal** In order to prevent environmental contamination, disposal of the lubrication system FAG CONCEPT8 must be carried out in accordance with the directives of the relevant country of use.

Components that are defective and cannot be repaired must be disposed of by environmentally acceptable methods.

All materials used (plastics, metals, electronic subassemblies) must be fed separately to recycling facilities.

Any used lubrication systems FAG CONCEPT8 and grease-soaked materials must be disposed of by environmentally acceptable methods.

The depleted lubricant cartridges contain residues of lubricant and must be disposed of together with waste materials containing oil or soaked with grease.

Electronic devices must be disposed of in accordance with the relevant regulations.

If there are problems relating to disposal in compliance with legal requirements and in an environmentally responsible manner, the complete lubrication system FAG CONCEPT8 can be returned to Schaeffler Technologies AG & Co. KG for disposal.

# Lubrication system FAG CONCEPT8

## Technical data and accessories

This chapter contains the technical data, accessories and replacement parts for the lubrication system FAG CONCEPT8.

## Technical data

Technical data for lubrication system FAG CONCEPT8, see *tables* and *Figure 63*.

### FAG CONCEPT8

Name	Value	Unit	
Lubricant volume (cartridge)	800	cm <sup>3</sup>	
Metering volume per delivery stroke	0,15	cm <sup>3</sup>	
Maximum number of outlets	8	–	
Hose connector: for hose outside diameter	8	mm	
■ CONCEPT8 minimum pressure capacity of hose	100	bar	
■ CONCEPT8-LIN for hose outside diameter	6	mm	
minimum pressure capacity of hose	100	bar	
■ CONCEPT8-CC for hose outside diameter	8	mm	
minimum pressure capacity of hose	100	bar	
Maximum operating pressure (at DC 24 V)	70	bar	
Operating voltage	24	V	
Operating temperature range	–20 to +70	°C	
Dimensions (with hose connectors)	Width	158	mm
	Height	273	mm
	Depth	152	mm
Mass without cartridge and lubricant	approx. 3 000	g	
Protection type	65	IP	
Connector	M12×1, 4 pin	–	
Housing material	Aluminium	–	



Further technical data:

- lubrication medium:
  - grease up to NLGI grade 2 (3<sup>1)</sup>)
- functional principle:
  - piston pump
- integrated controller with microprocessor
- integrated electronic pressure monitoring (measurement of back pressure)
- integrated fill level monitoring by Reed contact
- suitable for control of progressive distributors.

<sup>1)</sup> Greases to NLGI grade 3 can be reliably delivered only in a temperature range of +15 °C to +70 °C, in a hose with an outside diameter of 8 mm, an inside diameter of 5 mm and maximum length of 2,5 m.

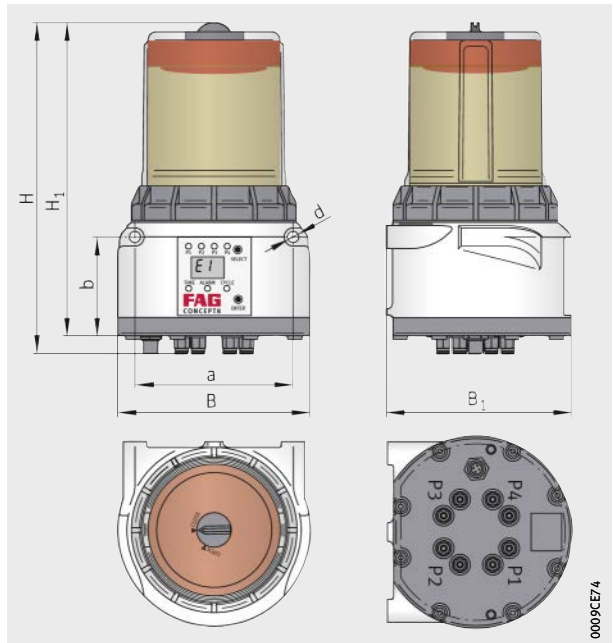

*Figure 63*  
Dimensions of FAG CONCEPT8

# Lubrication system FAG CONCEPT8

## Dimensions

Size		Value	Unit
Total height	H	273 ± 0,5	mm
Height of action pin to lower edge of lubrication system	H <sub>1</sub>	258 ± 0,5	mm
Total width	B	158 ± 0,5	mm
	B <sub>1</sub>	152 ± 0,5	mm
Distance between holes	a	130 ± 0,3	mm
Distance between hole centre and lower edge of lubrication system	b	81,2 ± 0,3	mm
Hole diameter	d	9	mm

## Hoses 8×5 and 6×4

Name		Value	Unit
Maximum operating pressure (at +20 °C)		90	bar
Operating temperature range		-20 to +80	°C
Minimum bending radius (suitable for flexible trunking)	∅ 6 mm	35	mm
	∅ 8 mm	45	mm

p = pressure  
T = temperature

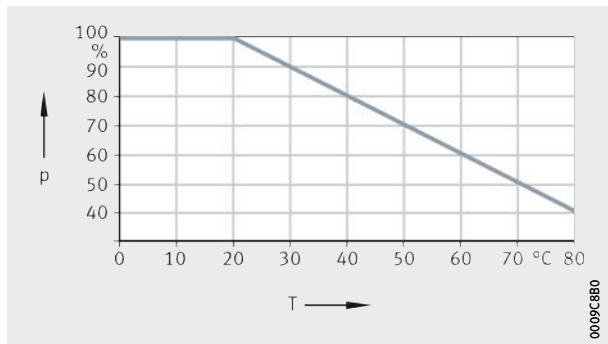

Figure 64  
Pressure/temperature diagram  
Hoses 8×5 and 6×4

The pressure resistance of hoses decreases with increasing temperature, *Figure 64*. At higher temperatures, the pressure resistance may fall below the maximum operating pressure of the device (70 bar).

In order to prevent rupture of the hoses, the pressure resistance must be checked under the following conditions:

- When using a hose 8×5 or 6×4:
  - temperature above +40 °C.

**Accessories** This chapter contains the accessories and replacement parts for the lubrication system FAG CONCEPT8.

**Connection cable for mains power pack** Connection cable for mains power pack, see *tables*.

**Standard connection cable**

Designation	SAP no.	Ordering designation
<ul style="list-style-type: none"> <li>■ Connection cable with 4 strands</li> <li>■ Connector M12×1</li> <li>■ Length 10 m</li> </ul>	075378361-0000-10	ARCALUB-X. CABLE-M12-10M

**Connection cable with LED head**

Designation	SAP no.	Ordering designation
<ul style="list-style-type: none"> <li>■ Connection cable with 4 strands</li> <li>■ Connector M12×1 with LED head</li> <li>■ Angled 90°</li> <li>■ Length 5 m</li> </ul>	075592240-0000-10	ARCALUB-X. CABLE-M12-5M-LED
<ul style="list-style-type: none"> <li>■ Connection cable with 4 strands</li> <li>■ Connector M12×1 with LED head</li> <li>■ Angled 90°</li> <li>■ Length 10 m</li> </ul>	077879805-0000-10	ARCALUB-X. CABLE-M12-10M-LED
<ul style="list-style-type: none"> <li>■ Connection cable with 4 strands</li> <li>■ Connector M12×1 with LED head</li> <li>■ Straight</li> <li>■ Length 5 m</li> </ul>	083788964-0000-10	ARCALUB-X. CABLE-M12-5M-LED-S
<ul style="list-style-type: none"> <li>■ Connection cable with 4 strands</li> <li>■ Connector M12×1 with LED head</li> <li>■ Straight</li> <li>■ Length 10 m</li> </ul>	083788980-0000-10	ARCALUB-X. CABLE-M12-10M-LED-S

# Lubrication system FAG CONCEPT8

## Mains power pack DC 24 V

Designation	SAP no.	Ordering designation
Mains power pack DC 24 V	083872507-0000-10	ARCALUB-X. POWER-SUPPLY-UNIT

**Grease cartridges** For the lubricator FAG CONCEPT8, standard grease cartridges of 800 cm<sup>3</sup> are available with various greases, see *table*.

## Standard grease cartridges 800 cm<sup>3</sup>

Designation	SAP no.	Ordering designation
Arcanol MOTION2	089922832-0000-10	ARCALUB-C8.LC800-MOTION2
Arcanol CLEAN-M	083549129-0000-10	ARCALUB-C8.LC800-CLEAN-M
Arcanol FOOD2	083549064-0000-10	ARCALUB-C8.LC800-FOOD2
Arcanol LOAD150	083532439-0000-10	ARCALUB-C8.LC800-LOAD150
Arcanol LOAD220	083533583-0000-10	ARCALUB-C8.LC800-LOAD220
Arcanol LOAD400	083533761-0000-10	ARCALUB-C8.LC800-LOAD400
Arcanol LOAD460	083533818-0000-10	ARCALUB-C8.LC800-LOAD460
Arcanol LOAD1000	083548343-0000-10	ARCALUB-C8.LC800-LOAD1000
Arcanol MULTI2	083532412-0000-10	ARCALUB-C8.LC800-MULTI2
Arcanol MULTI3	083548289-0000-10	ARCALUB-C8.LC800-MULTI3
Arcanol MULTITOP	082631492-0000-10	ARCALUB-C8.LC800-MULTITOP
Arcanol SPEED2,6	083548629-0000-10	ARCALUB-C8.LC800-SPEED2,6
Arcanol TEMP90	083533630-0000-10	ARCALUB-C8.LC800-TEMP90
Arcanol TEMP110	083548580-0000-10	ARCALUB-C8.LC800-TEMP110
Arcanol TEMP120	083548599-0000-10	ARCALUB-C8.LC800-TEMP120
Arcanol TEMP200	083548602-0000-10	ARCALUB-C8.LC800-TEMP200
Arcanol VIB3	083549099-0000-10	ARCALUB-C8.LC800-VIB3

On request, the cartridges can also be filled with a special grease.

## Accessories for filling of hoses

This chapter contains the filling accessories for the filling of hoses using a hand-lever press.

### Filling accessories

Designation	SAP no.	Ordering designation
Hand-lever press	039064115-0000-10	ARCA-GREASE-GUN
Hose cutting tool	083788620-0000-10	ARCALUB-X.HOSE-CUTTOOL

### Standard grease containers for filling of hand-lever press

Designation	SAP no.	Ordering designation
400 g cartridge containing		
Arcanol MOTION2	080266258-0000-10	ARCANOL-MOTION2-400G
Arcanol CLEAN-M	069429111-0000-10	ARCANOL-CLEAN-M-400G
Arcanol FOOD2	019143648-0000-10	ARCANOL-FOOD2-400G
Arcanol LOAD150	055358152-0000-10	ARCANOL-LOAD150-400G
Arcanol LOAD220	064741028-0000-10	ARCANOL-LOAD220-400G
Arcanol LOAD400	019143818-0000-11	ARCANOL-LOAD400-400G
Arcanol LOAD460	065825144-0000-10	ARCANOL-LOAD460-400G
Arcanol MULTI2	019143893-0000-11	ARCANOL-MULTI2-400G
Arcanol MULTI3	016727355-0000-11	ARCANOL-MULTI3-400G
Arcanol MULTITOP	019144016-0000-11	ARCANOL-MULTITOP-400G
Arcanol SPEED2,6	062447610-0000-10	ARCANOL-SPEED2,6-400G
Arcanol TEMP90	019144172-0000-10	ARCANOL-TEMP90-400G
Arcanol TEMP110	019144075-0000-10	ARCANOL-TEMP110-400G
Arcanol VIB3	055289568-0000-10	ARCANOL-VIB3-400G
1 kg can containing		
Arcanol TEMP120	038652200-0000-10	ARCANOL-TEMP120-1KG
Arcanol TEMP200	019144121-0000-10	ARCANOL-TEMP200-1KG
5 kg bucket containing		
Arcanol LOAD1000	019003463-0000-10	ARCANOL-LOAD1000-5KG

### Hose connectors for hand-lever press

Designation	SAP no.	Ordering designation
Hose connectors for hoses of 8 mm outside diameter		
M10×1	083654356-0000-10	ARCALUB-X.TUBEFIT-M10X1-SAT108G
G <sup>1</sup> / <sub>8</sub>	083654534-0000-10	ARCALUB-X.TUBEFIT-G1/8-SAT188G
Hose connectors for hoses of 6 mm outside diameter		
M10×1	075527626-0000-10	ARCALUB-X.TUBEFIT-M10X1-SAT106G
G <sup>1</sup> / <sub>8</sub>	084465905-0000-10	ARCALUB-X.TUBEFIT-G1/8-SAT186G

# Lubrication system FAG CONCEPT8

**Accessories**  
for CONCEPT8 and CONCEPT8-CC

This chapter contains the accessories for the lubrication system FAG CONCEPT8 and FAG CONCEPT8-CC, see *tables*.

**Hoses**  
for CONCEPT8 and CONCEPT8-CC

Designation	SAP no.	Ordering designation
<ul style="list-style-type: none"> <li>■ Hose PA 66</li> <li>■ 8×5 mm</li> <li>■ Black</li> <li>■ Unfilled</li> <li>■ Length 5 m</li> </ul>	083788573-0000-10	ARCALUB-X.HOSE-PA66-5M
<ul style="list-style-type: none"> <li>■ Hose PA 66</li> <li>■ 8×5 mm</li> <li>■ Black</li> <li>■ Unfilled</li> <li>■ Length 10 m</li> </ul>	083788581-0000-10	ARCALUB-X.HOSE-PA66-10M
<ul style="list-style-type: none"> <li>■ Hose PA 66</li> <li>■ 8×5 mm</li> <li>■ Black</li> <li>■ Unfilled</li> <li>■ Length 50 m</li> </ul>	083788603-0000-10	ARCALUB-X.HOSE-PA66-50M

**Hose connectors  
for CONCEPT8 and CONCEPT8-CC  
(hose 8×5 mm)**

Designation	SAP no.	Ordering designation
<b>Hose connector for hose 8×5 mm</b>		
<ul style="list-style-type: none"> <li>■ Hose, push fit</li> <li>■ Threaded connector M8×1</li> <li>■ Straight</li> </ul>	083654216-0000-10	ARCALUB-X. TUBEFIT-M8X1-SAT088G
<ul style="list-style-type: none"> <li>■ Hose, push fit</li> <li>■ Threaded connector M8×1</li> <li>■ Angled</li> </ul>	083654275-0000-10	ARCALUB-X. TUBEFIT-M8X1-SAT088W
<ul style="list-style-type: none"> <li>■ Hose, push fit</li> <li>■ Threaded connector M10×1</li> <li>■ Straight</li> </ul>	083654356-0000-10	ARCALUB-X. TUBEFIT-M10X1-SAT108G
<ul style="list-style-type: none"> <li>■ Hose, push fit</li> <li>■ Threaded connector M10×1</li> <li>■ Angled 90°</li> </ul>	083654402-0000-10	ARCALUB-X. TUBEFIT-M10X1-SAT108W
<ul style="list-style-type: none"> <li>■ Hose, push fit</li> <li>■ Threaded connector G<sup>1</sup>/<sub>8</sub></li> <li>■ Straight</li> </ul>	083654534-0000-10	ARCALUB-X. TUBEFIT-G1/8-SAT188G
<ul style="list-style-type: none"> <li>■ Hose, push fit</li> <li>■ Threaded connector G<sup>1</sup>/<sub>8</sub></li> <li>■ Angled</li> </ul>	083654577-0000-10	ARCALUB-X. TUBEFIT-G1/8-SAT188W
<ul style="list-style-type: none"> <li>■ Hose, push fit</li> <li>■ Threaded connector G<sup>1</sup>/<sub>4</sub></li> <li>■ Straight</li> </ul>	083654607-0000-10	ARCALUB-X. TUBEFIT-G1/4-SAT148G
<ul style="list-style-type: none"> <li>■ Hose, push fit</li> <li>■ Threaded connector G<sup>1</sup>/<sub>4</sub></li> <li>■ Angled</li> </ul>	083654623-0000-10	ARCALUB-X. TUBEFIT-G1/4-SAT148W
<b>Y type connector for hose 8×5 mm</b>		
<ul style="list-style-type: none"> <li>■ Hose, push fit</li> <li>■ Connection of 2 pump outlets to 1 lubrication inlet</li> </ul>	083654640-0000-10	ARCALUB-X. TUBEFIT-Y-D8

# Lubrication system FAG CONCEPT8

**Accessories for CONCEPT8-LIN** This chapter contains the accessories for the lubrication system FAG CONCEPT8-LIN, see *tables*.

## Hoses for CONCEPT8-LIN

Designation	SAP no.	Ordering designation
<ul style="list-style-type: none"> <li>■ Hose PA 12</li> <li>■ 6×4 mm</li> <li>■ Black</li> <li>■ Unfilled</li> <li>■ Length 5 m</li> </ul>	076691217-0000-10	ARCALUB-X. HOSE-PA12-5M
<ul style="list-style-type: none"> <li>■ Hose PA 12</li> <li>■ 6×4 mm</li> <li>■ Black</li> <li>■ Unfilled</li> <li>■ Length 10 m</li> </ul>	076691497-0000-10	ARCALUB-X. HOSE-PA12-10M
<ul style="list-style-type: none"> <li>■ Hose PA 12</li> <li>■ 6×4 mm</li> <li>■ Black</li> <li>■ Unfilled</li> <li>■ Length 50 m</li> </ul>	085842109-0000-10	ARCALUB-X. HOSE-PA12-50M

## Hose connectors for CONCEPT8-LIN (hose 6×4 mm)

Designation	SAP no.	Ordering designation
Hose connector for hose 6×4 mm		
<ul style="list-style-type: none"> <li>■ Hose, push fit</li> <li>■ Connection thread M5</li> <li>■ Straight</li> </ul>	077937490-0000-10	ARCALUB-X. TUBEFIT-M5-SAT056G
<ul style="list-style-type: none"> <li>■ Hose, push fit</li> <li>■ Connection thread M5</li> <li>■ Angled</li> </ul>	079567401-0000-10	ARCALUB-X. TUBEFIT-M5-SAT056W
<ul style="list-style-type: none"> <li>■ Hose, push fit</li> <li>■ Connection thread M6</li> <li>■ Straight</li> </ul>	075527472-0000-10	ARCALUB-X. TUBEFIT-M6-SAT066G
<ul style="list-style-type: none"> <li>■ Hose, push fit</li> <li>■ Connection thread M6</li> <li>■ Angled 90°</li> </ul>	075676621-0000-10	ARCALUB-X. TUBEFIT-M6-SAT066W



**Hose connectors  
for CONCEPT8-LIN  
(hose 6×4 mm)  
(continued)**

Designation	SAP no.	Ordering designation
Hose connector for hose 6×4 mm		
<ul style="list-style-type: none"> <li>■ Hose, push fit</li> <li>■ Threaded connector M8×1</li> <li>■ Straight</li> </ul>	079567428-0000-10	ARCALUB-X. TUBEFIT-M8X1-SAT086G
<ul style="list-style-type: none"> <li>■ Hose, push fit</li> <li>■ Threaded connector M8×1</li> <li>■ Angled</li> </ul>	079567584-0000-10	ARCALUB-X. TUBEFIT-M8X1-SAT086W
<ul style="list-style-type: none"> <li>■ Hose, push fit</li> <li>■ Threaded connector M10×1</li> <li>■ Straight</li> </ul>	075527626-0000-10	ARCALUB-X. TUBEFIT-M10X1-SAT106G
<ul style="list-style-type: none"> <li>■ Hose, push fit</li> <li>■ Threaded connector M10×1</li> <li>■ Angled 90°</li> </ul>	076968553-0000-10	ARCALUB-X. TUBEFIT-M10X1-SAT106W
<ul style="list-style-type: none"> <li>■ Hose, push fit</li> <li>■ Threaded connector G<sup>1</sup>/<sub>8</sub></li> <li>■ Straight</li> </ul>	084465905-0000-10	ARCALUB-X. TUBEFIT-G1/8-SAT186G
<ul style="list-style-type: none"> <li>■ Hose, push fit</li> <li>■ Threaded connector G<sup>1</sup>/<sub>8</sub></li> <li>■ Angled</li> </ul>	084465964-0000-10	ARCALUB-X. TUBEFIT-G1/8-SAT186W
<ul style="list-style-type: none"> <li>■ Hose, push fit</li> <li>■ Threaded connector G<sup>1</sup>/<sub>4</sub></li> <li>■ Straight</li> </ul>	079567606-0000-10	ARCALUB-X. TUBEFIT-G1/4-SAT146G
<ul style="list-style-type: none"> <li>■ Hose, push fit</li> <li>■ Threaded connector G<sup>1</sup>/<sub>4</sub></li> <li>■ Angled</li> </ul>	079567622-0000-10	ARCALUB-X. TUBEFIT-G1/4-SAT146W
Y type connector for hose 6×4 mm		
<ul style="list-style-type: none"> <li>■ Hose, push fit</li> <li>■ Connection of 2 pump outlets to 1 lubrication inlet</li> </ul>	076693180-0000-10	ARCALUB-X. TUBEFIT-Y-D6

**Schaeffler Technologies AG & Co. KG**

Georg-Schäfer-Straße 30  
97421 Schweinfurt  
Germany

Internet [www.fag.com](http://www.fag.com)  
E-mail [faginfo@schaeffler.com](mailto:faginfo@schaeffler.com)

In Germany:

Phone 0180 5003872  
Fax 0180 5003873

From other countries:

Phone +49 9721 91-0  
Fax +49 9721 91-3435

Every care has been taken to ensure the correctness of the information contained in this publication but no liability can be accepted for any errors or omissions. We reserve the right to make technical changes.

© Schaeffler Technologies AG & Co. KG  
Issued: 2017, March

This publication or parts thereof may not be reproduced without our permission.  
BA 36 GB-D